



**A Leading Manufacturer And Exporting Company of Dental  
Instruments to all over the World**

***Dental  
Instruments***



**RP-101**  
**Fig-1**  
Upper centrals  
& canines



**RP-102**  
**Fig-2**  
Upper laterals  
& bicuspids



**RP-103**  
**Fig-3**  
Upper incisors  
& canines



**RP-104**  
**Fig-4**  
Lower incisors  
& canines



**RP-105**  
**Fig-7**  
Upper primolars



**RP-106**  
**Fig-8**  
Lower primolars



**RP-107**  
**Fig-13**  
Lower primolars



**RP108**  
**Fig-17**  
**Right upper molars**



**RP109**  
**Fig-18**  
**Left upper molars**



**RP110**  
**Fig-18A**  
**upper molars**



**RP111**  
**Fig-19**  
**upper wisdom**



**RP112**  
**Fig-20**  
**Lower wisdoms**



**RP113**  
**Fig-21**  
**Lower molars**



**RP114**  
**Fig-22**  
**Lower molars**  
**Hawk's bill**



**RP115**  
**Fig-23**  
**Right lower molars**



**RP116**  
**Fig-24**  
**Left lower molars**



**RP117**  
**Fig-29**  
**Upper roots & incisors**



**RP118**  
**Fig-29N**  
**Roots of Upper incisors**



**RP119**  
**Fig-30**  
**Upper roots & incisors**

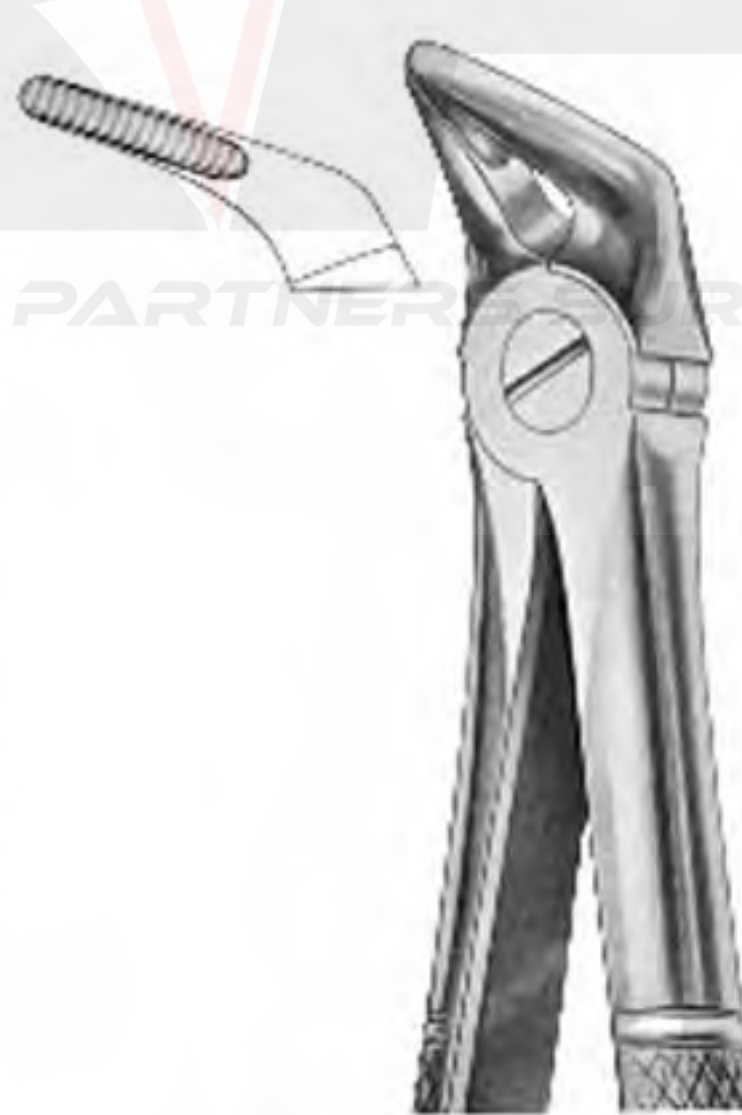

**RP120**  
**Fig-31**  
**Lower roots**



**RP121**  
**Fig-32**  
**Lower molars**



**RP122**  
**Fig-33**  
Lower roots



**RP123**  
**Fig-33A**  
Lower roots



**RP124**  
**Fig-33C**  
Lower roots



**RP125**  
**Fig-33M**  
Lower roots  
with long beak



**RP126**  
**Fig-41**  
Upper roots



**RP127**  
**Fig-44**  
Upper roots



**RP128**  
**Fig-45**  
Lower roots



**RP129**  
**Fig-51**  
Upper roots



**RP130**  
**Fig-51A**  
Upper roots  
narrow beak



**RP131**  
**Fig-51C**  
Upper roots



**RP132**  
**Fig-52**  
Upper roots & canines  
with wider beak



**RP133**  
**Fig-52A**  
Upper roots  
& resection



**RP134**  
**Fig-55**  
Separating Upper  
molars roots



**RP135**  
**Fig-56**  
Separating lower  
molars roots



**RP136**  
**Fig-67**  
Upper wisdoms



**RP137**  
**Fig-67A**  
Upper wisdoms



**RP-138**  
**Fig-68**  
**Lower roots**



**RP139**  
**Fig-73**  
**Lower molars**  
**hawk, s bill**



**RP140**  
**Fig-74**  
**Lower incisors**  
**& roots**



**RP141**  
**Fig-74M**  
**Lower incisors**  
**& roots**



**RP142**  
**Fig-74N**  
**Lower incisors**  
**& roots**



**RP143**  
**Fig-75**  
**Lower primolars**  
**& canines**



**RP144**  
**Fig-76**  
**Upper roots**



**RP145**  
**Fig-76N**  
**Upper roots**  
**narrow beak**



**RP146**  
**Fig-79**  
**Lower wisdoms**



**RP147**  
**Fig-79A**  
**Lower wisdoms**



**RP148**  
**Fig-86A**  
**Lower molars**



**RP149**  
**Fig-86B**  
**Lower molars**



**RP150**  
**Fig-86C**  
**Lower Molars**



**RP151**  
**Fig-87**  
**Cowhom beak**



**RP152**  
**Fig-89**  
**Right Upper Molars**



**RP153**  
**Fig-90**  
**Left Upper Molars**





**RP154**  
**Fig-94**  
Right upper molars



**RP155**  
**Fig-95**  
Left upper molars



**RP156**  
**Fig-99**  
Lower molars  
broken-down



**RP157**  
**Fig-99<sub>1/4</sub>**  
Lower molars  
broken-down

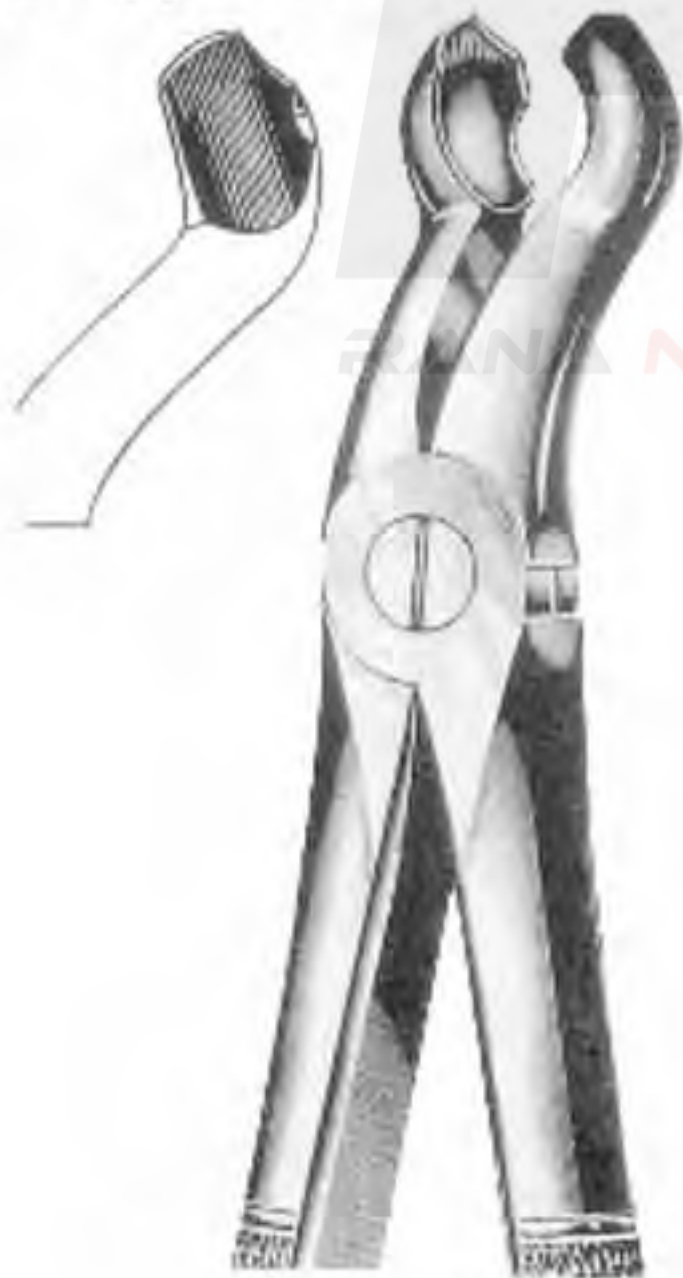

**RP158**  
**Fig-121**  
Upper wisdoms



**RP159**  
**Fig-136**  
Upper central  
& roots



**RP160**  
**Fig-137**  
lower central  
& roots



**RP161**  
**Fig-167**  
Universal pattern  
for lower teeth  
molars & primolars



**RP-162**  
**Fig-168**  
**Upper canines**



**RP-163**  
**Fig-169**  
**Lower canines & primolars**



**RP-164**  
**Fig-233**  
**Lower Roots (parallel beaks)**



**RP-165**  
**Fig-235**  
**Upper Roots (parallel beaks)**



**RP-166**  
**Fig-MD1**  
**Universal forceps for upper wisdom, & roots**



**RP-167**  
**Fig-MD2**  
**Upper Molars**



**RP-168**  
**Fig-MD3**  
**Lower incisors & primolars**



**RP-169**  
**Fig-MD4**  
**Lower molars**

RANA NAJEEB & PARTNERS SURGICAL



**RP170**  
**Fig-158**

**Children upper molars universal**

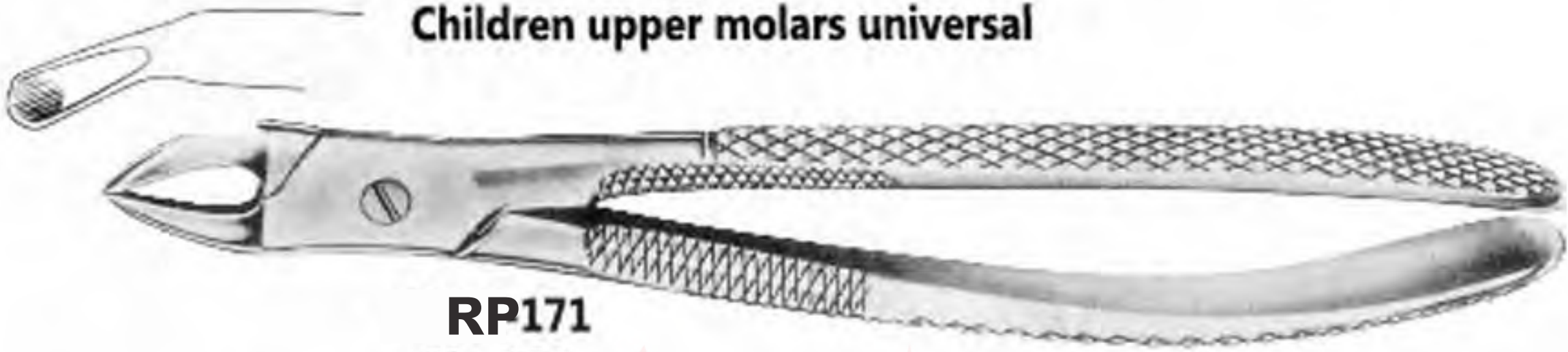

**RP171**  
**Fig-159**

**Children upper teeth universal**



**RP172**  
**Fig-160**

**Children lower molars universal hawk,s bill**

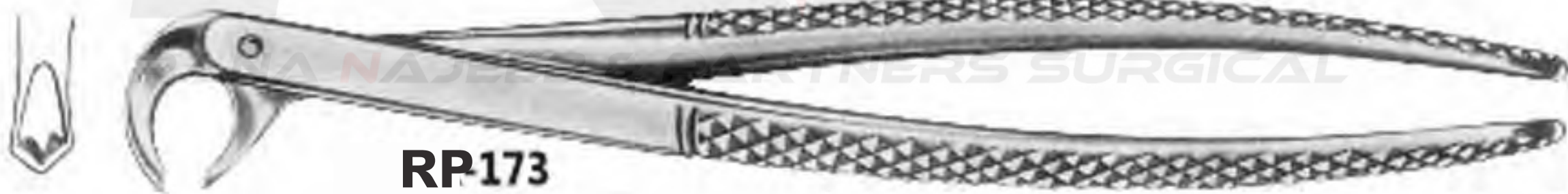

**RP173**  
**Fig-161**

**Children lower central & roots**



**RP174**  
**Fig-162**

**Children upper central**



**RP175**  
**Fig-163**

**Children upper central**



**RP-181**  
Universal pattern for  
upper teeth



**RP-182**  
Universal pattern for  
lower teeth



**RP-183**  
Fig-22 <sup>1</sup>/<sub>2</sub>L  
Left lower  
wisdoms &  
molars



**RP-184**  
Fig-22 <sup>1</sup>/<sub>2</sub>R  
Right lower  
wisdoms &  
molars



**RP181**  
Universal pattern for  
upper teeth



**RP182**  
Universal pattern for  
lower teeth



**RP183**  
Fig-22  $\frac{1}{2}L$   
Left lower  
wisdoms &  
molars



**RP184**  
Fig-22  $\frac{1}{2}R$   
Right lower  
wisdoms &  
molars

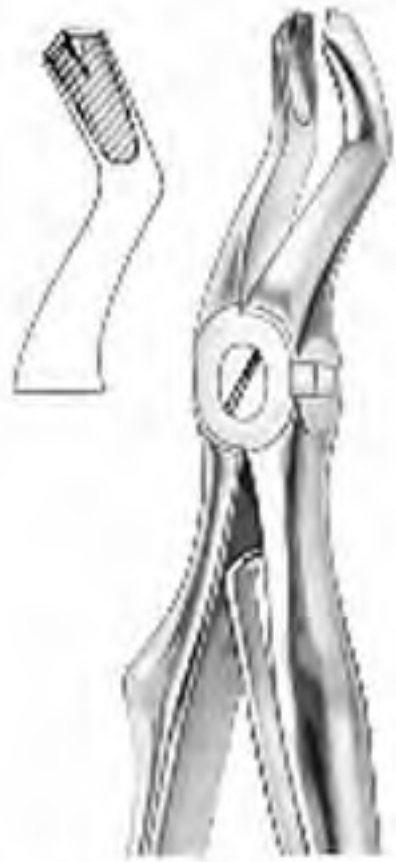

**RP185**  
**Fig-3**  
**Upper molars**



**RP186**  
**Fig-5**  
**Lower incisors**



**RP187**  
**Fig-6**  
**Lower molars**



**RP188**  
**Fig-7**  
**Lower molar**



**RP189**  
**Fig-137**  
**Upper incisors & canines**



**RP190**  
**Fig-139**  
**Upper premolars**



**RP191**  
**Fig-51S**  
**Upper roots**



**RP192**  
**Fig-1**  
Upper central, lateral  
& cuspid

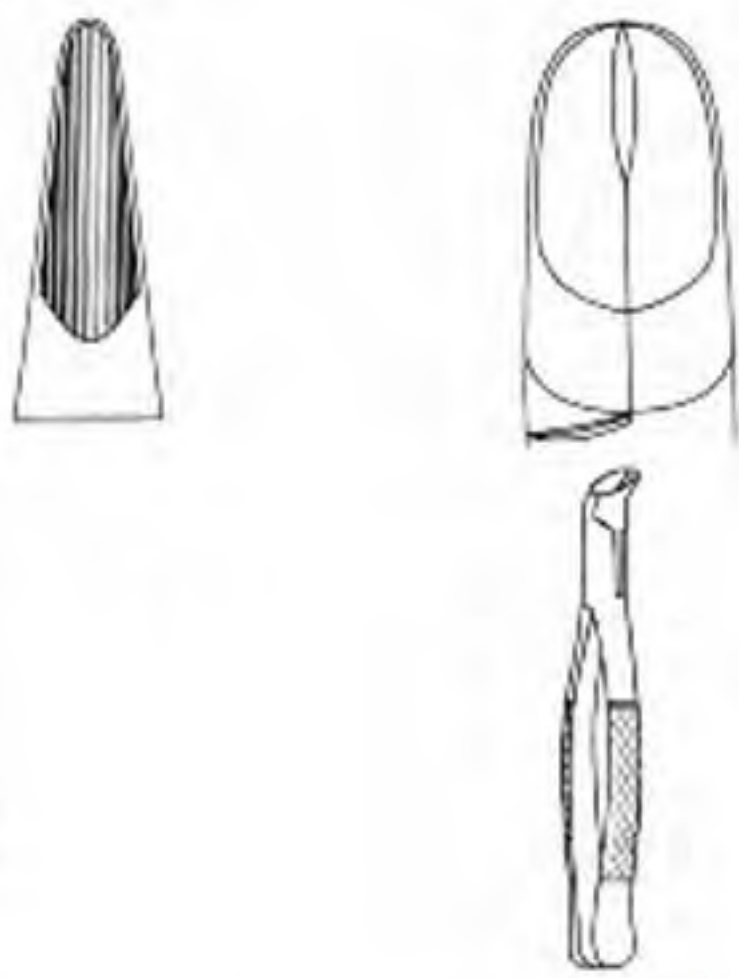

**RP193**  
**Fig-5**  
Lower third molars



**RP194**  
**Fig-6**  
Splitting Forceps

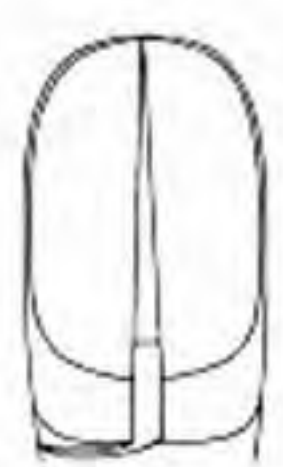

**RP195**  
**Fig-10H**  
Upper molars  
Hook-handle

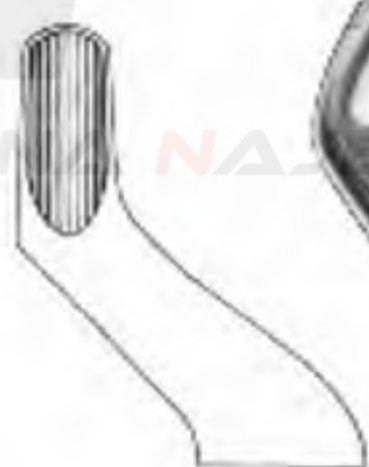

**RP196**  
**Fig-10S**  
Upper molars  
Straight-handle



**RP197**  
**Fig-15**  
Upper molars  
Hook-handle





**RP-198**  
**Fig-16S**  
**Lower molars children**



**RP-199**  
**Fig-16**  
**Lower molars**  
**cow-horn beak**



**RP-200**  
**Fig-17**  
**Lower molars**



**RP-201**  
**Fig-18L**  
**Upper molars**  
**left side**



**RP-202**  
**Fig-18R**  
**Upper molars**  
**right side**



**RP-203**  
**Fig-23**  
**Upper molars**  
**cow-horn beak**





**RP-204**  
**Fig-32**  
Upper molars & premolars  
strong beak



**RP-205**  
**Fig-53L**  
Upper molar lift side



**RP-206**  
**Fig-53R**  
Upper molar right side



**RP207**  
**Fig-62**  
Universal forceps for  
upper teeth & roots



**RP208**  
**Fig-65**  
Upper incisors & root



**RP209**  
**Fig-69**  
Fregmants & small roots  
upper & lower



**RP-210**

**Fig-88R**

**Right upper molars**



**RP-211**

**Fig-88L**

**Left upper molars**

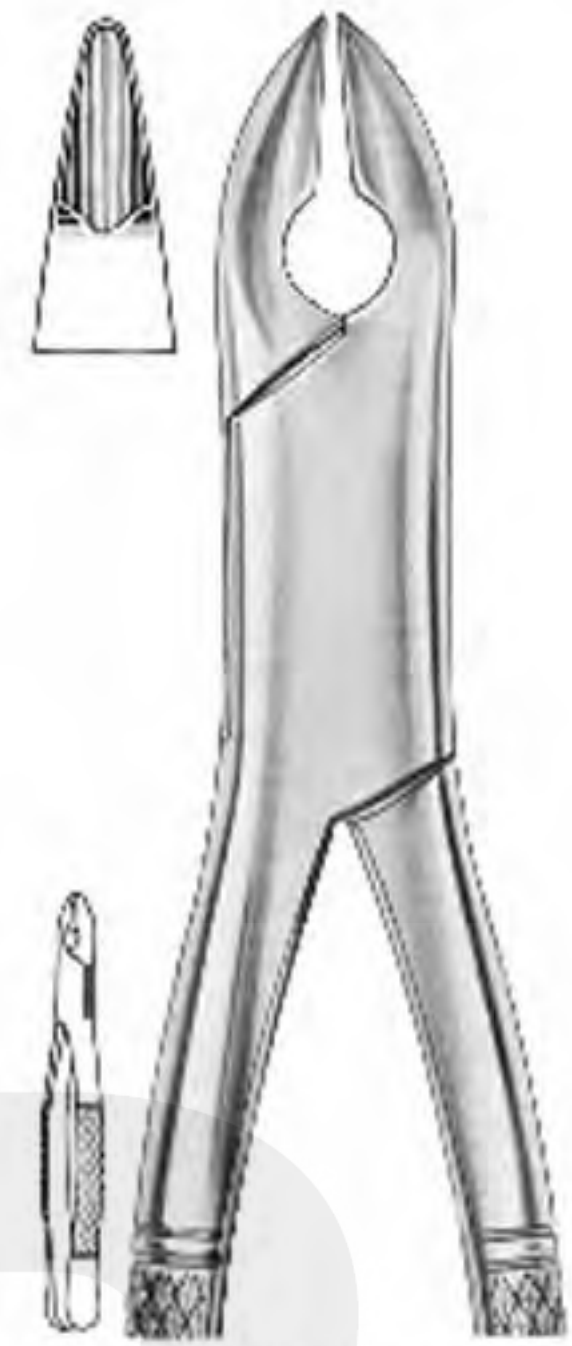

**RP-212**

**Fig-99C**

**Upper premolars,  
molars, incisors**



**RP-213**

**Fig-101**

**Universal forceps  
for premolars,**



**RP-214**

**Fig-150**

**Upper premolars,  
molars, roots**



**RP-215**

**Fig-150A**

**Upper premolars,  
molars, roots**



**RP-216**

**Fig-150S**

**Upper premolars,  
incisors, roots**



**RP-217**  
**Fig-151**  
Lower premolars,  
incisors & roots



**RP-218**  
**Fig-151A**  
Lower premolars,  
incisors & roots



**RP-219**  
**Fig-151S**  
Lower premolars,  
incisors & roots



**RP-220**  
**Fig-210H/S**  
Upper wisdoms  
with hook & straight handle



**RP-222**  
**Fig-222**  
Lower wisdoms

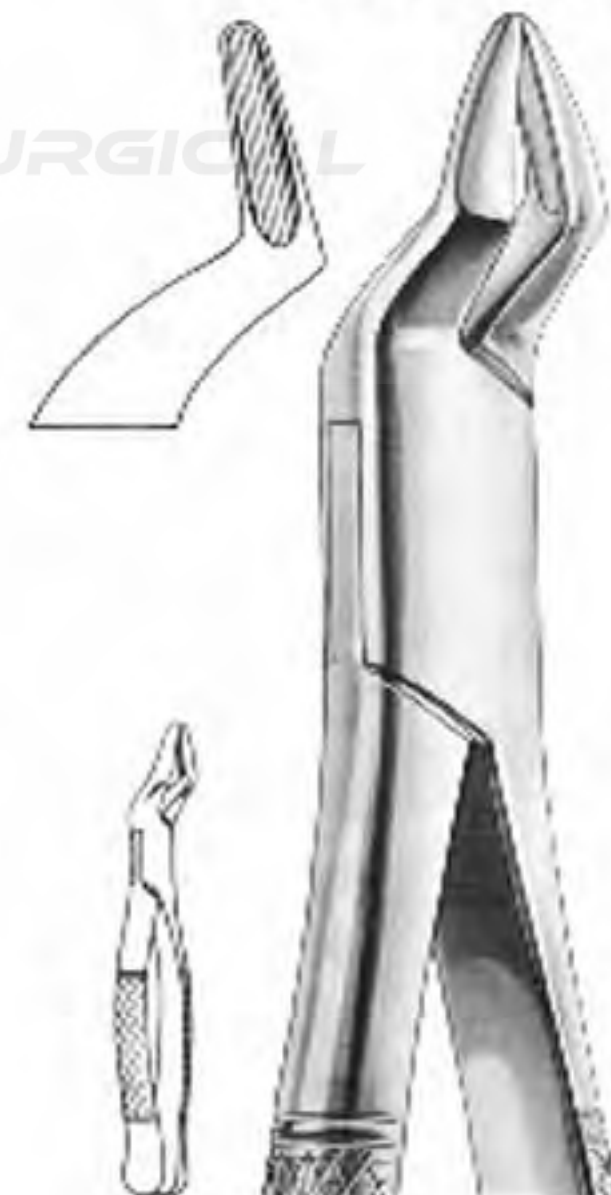

**RP-223**  
**Fig-286**  
Upper roots, premolars  
& incisors



**RP-224**  
**Fig-1**  
**Lower roots**



**RP-225**  
**Fig-2**  
**Upper roots**



**RP-226**  
**Albrecht**  
**16 cm**



**RP-227**  
**Albrecht**  
**16 cm**



**RP-228**  
**Fig-1**  
**Root fragment**



**RP-229**  
**Fig-2**  
**Root fragment**



**RP-230**  
Blumenthal  
15 cm



**RP-231**  
Blumenthal  
14.5 cm



**RP-232**  
Blumenthal  
14 cm

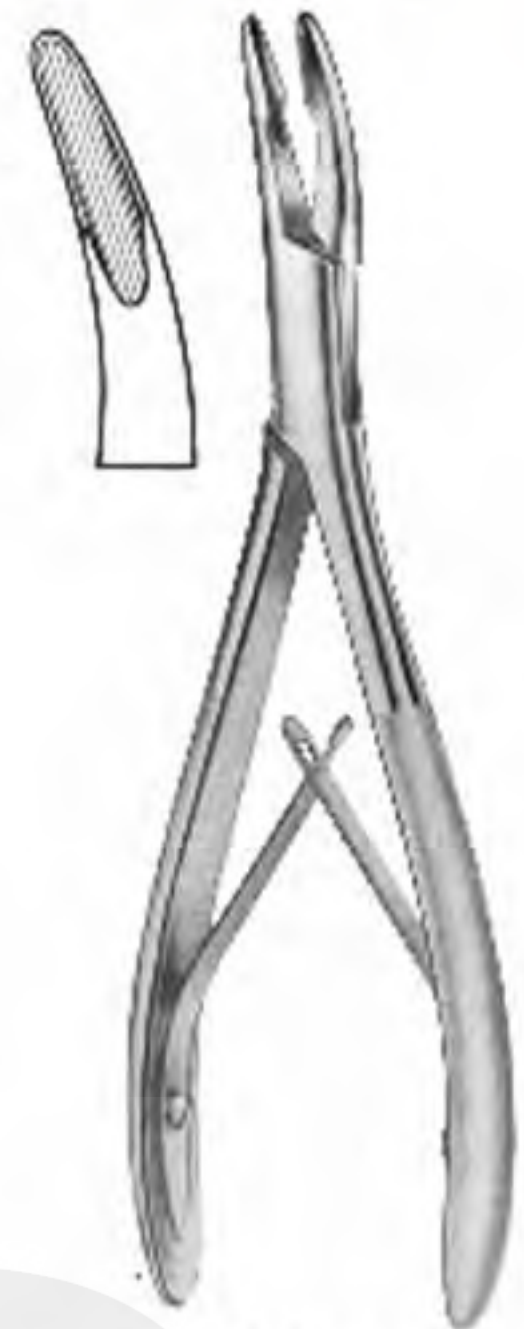

**RP-233**  
Mead 1A  
16 cm



**RP-234**  
Beyer  
18 cm



**RP-235**  
Ruskin-mini  
15.5 cm

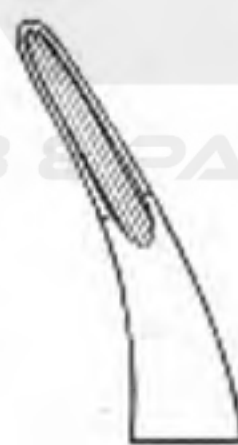

**RP-236**  
Luer  
15 cm



**RP-237**  
Friadman  
14 cm



**RP-238**  
Mini friadman  
12 cm

**Multiple Action**

# ROOT ELEVATORS



**RP239**  
Fig-1B  
Bein

3 mm

4 mm

3 mm

4 mm

3.2 mm

3.8 mm



**RP240**  
Fig-2B  
Bein



**RP241**  
Fig-3B  
Bein



**RP242**  
4Fig-3B  
Bein



**RP243**  
Fig-5B  
Bein



**RP244**  
Fig-6B  
Bein



**RP245**  
Fig-4SA  
Schmeckeblrier-apexo



**RP246**  
Fig-5SA



**RP247**  
Fig-34S  
Seldin



**RP248**  
Fig-34  
Seldin



**RP249**  
Fig-2S  
Seldin



**RP250**  
Fig-3S  
Seldin



**RP251**  
Fig-1F  
Flohr



**RP252**  
Fig-2F  
Flohr



**RP253**  
Fig-3F  
Flohr

# ROOT ELEVATORS



**RP-254**  
**Fig-71**  
**Miller-Apexo**



**RP-255**  
**Fig-72**  
**Miller-Apexo**



**RP-256**  
**Fig-73**  
**Miller-Apexo**



**RP-257**  
**Fig-74**  
**Miller-Apexo**



**RP-258**  
**Fig-19**



**RP-259**  
**Fig-20**



**RP-260**  
**Fig-51**  
**Curtis**



**RP-261**  
**Fig-52**  
**Curtis**



**RP-262**  
**Fig-1L**  
**Seldin**



**RP-263**  
**Fig-1R**  
**Seldin**



**RP-264**  
**Fig-4L**  
**Seldin**



**RP-265**  
**Fig-4R**  
**Seldin**



**RP-266**  
**Fig-11**  
**Stout**



**RP-267**  
**Fig-11A**  
**Stout**



**RP-268**  
**Fig-44C**  
**Stout**

# ROOT ELEVATORS



**RP-269**  
**Fig-A**  
**Cogswell**



**RP-270**  
**Fig-B**  
**Cogswell**



**RP-271**  
**Fig-301**  
**Apexo**



**RP-272**  
**Fig-302**  
**Apexo**



**RP-273**  
**Fig-303**  
**Apexo**



**RP-274**  
**Fig-301W**  
**Seldin**



**RP-275**  
**Fig-304W**  
**Seldin**



**RP-276**  
**Fig-1H**  
**Heibrink**



**RP-277**  
**Fig-2H**  
**Heibrink**



**RP-278**  
**Fig-40H**  
**Heibrink**



**RP-279**  
**Fig-41H**  
**Heibrink**



**RP-280**  
**Fig-46**



**RP-281**  
**Fig-46R**



# ROOT ELEVATORS



**RP-283**  
Fig-45  
Cryer

**RP284**  
Fig-25  
Cryer

**RP-285**  
Fig-26  
Cryer

**RP286**  
Fig-31  
Cryer

**RP287**  
Fig-32  
Cryer

**RP-288**  
Fig-80

**RP-289**  
Fig-81

**RP-282**  
Fig-44  
Cryer

**RP-290**  
Fig-81A

**RP-291**  
Fig-81E

**RP-292**  
Fig-190

**RP-293**  
Fig-191

**RP-294**  
Fig-23

**RP-295**  
Fig-24

**RP-296**  
Fig-98

RANA NAJEEB & PARTNERS SURGICAL

# ROOT ELEVATORS





**RP-313**  
**Fig-1**  
**Bein**



**RP-314**  
**Fig-2**  
**Bein**



**RP-315**  
**Fig-3**  
**Bein**



**RP-316**  
**Fig-4**  
**Bein**



**RP-317**  
**Fig-5**  
**Bein**



**RP-318**  
**Fig-6**  
**Bein**



**RP-319**  
**Fig-1**



**RP-320**  
**Fig-2**



**RP-321**  
**Fig-2**  
**Flohr**



**RP-322**  
**Fig-3**  
**Flohr**



**RP-323**  
**Fig-7**  
**Flohr**



**RP-324**  
**Fig-8**  
**Flohr**

# ROOT ELEVATORS

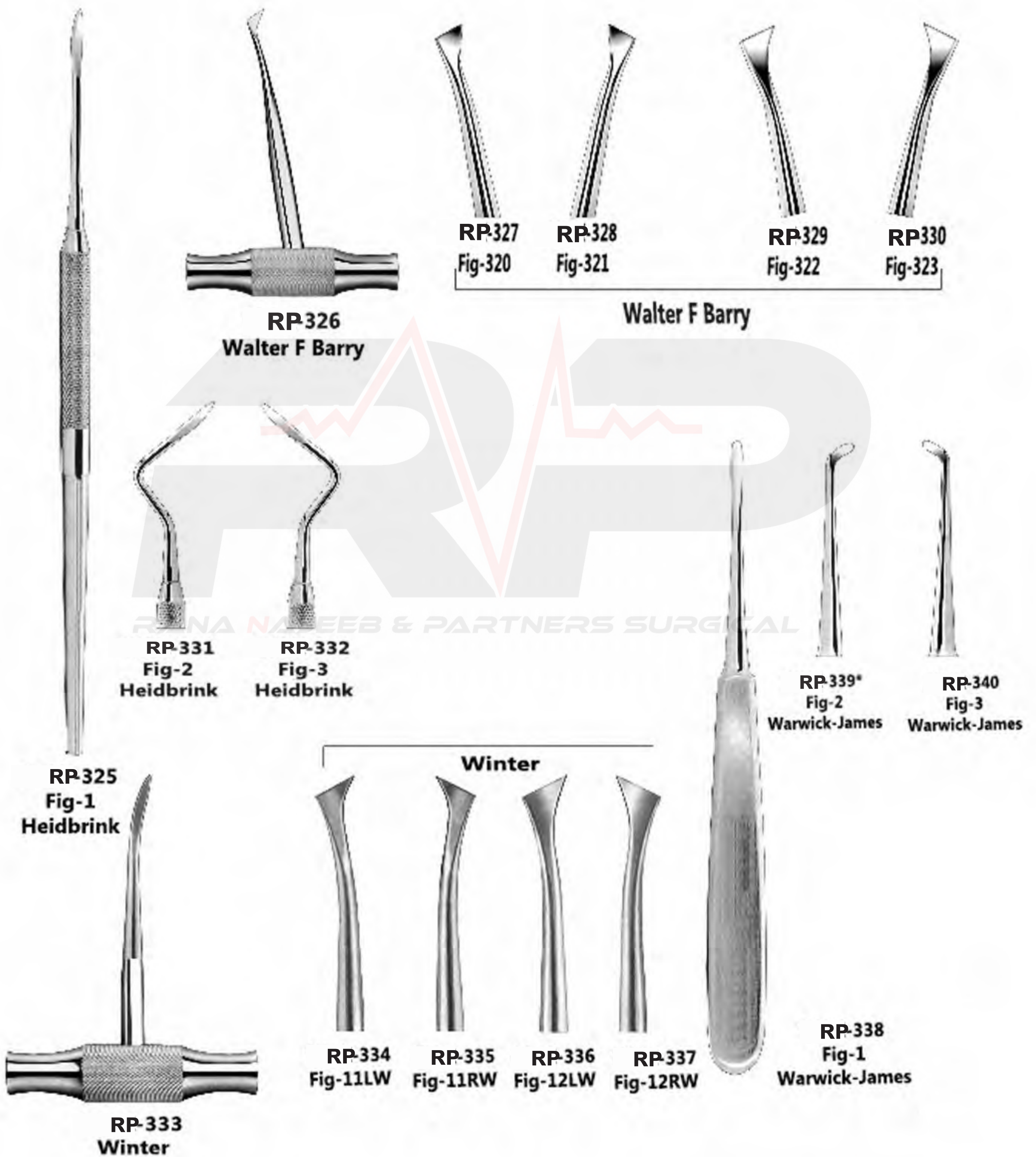



**RP-341  
Waldsachs  
15cm**



**RP-342  
Universal  
16cm**



**RP-343  
Nance  
13.5cm**



**RP-344  
Aderer  
14.5cm**



**RP-345  
Modell marburg  
serrated jaws  
14cm**



**RP-346  
Modell marburg  
Smooth Jaws  
14cm**



**RP-347  
Modell marburg  
Carbid Inserts Jaws  
14cm**



**RP-348  
Goslee  
one serrated jaws  
14cm**



**RP-349**  
14 cm



**RP-350**  
14 cm



**RP-351**  
14 cm



**RP-352**  
14.5 cm



**RP-353**  
14.5 cm



**RP-354**  
14 cm



**RP-355**  
14 cm



**RP-356**  
14 cm



**RP-357**  
Serrated jaws  
12 cm



**RP-358**  
How  
14.5cm



**RP-360**  
How-Angled  
14.5cm



**RP-360**  
Arrow Clasp forming  
12 cm



**RP-361**  
Arrow Clasp forming  
12 cm



**RP-362**  
Arrow Clasp bending  
12 cm



**RP-363**  
**Peeso**  
**13.5 cm**



**RP-364**  
**Peeso**  
**13.5 cm**



**RP-365**  
**Peeso**  
**14 cm**

Round nose plier



**RP-366**  
**Langenbeck**  
**14 cm**

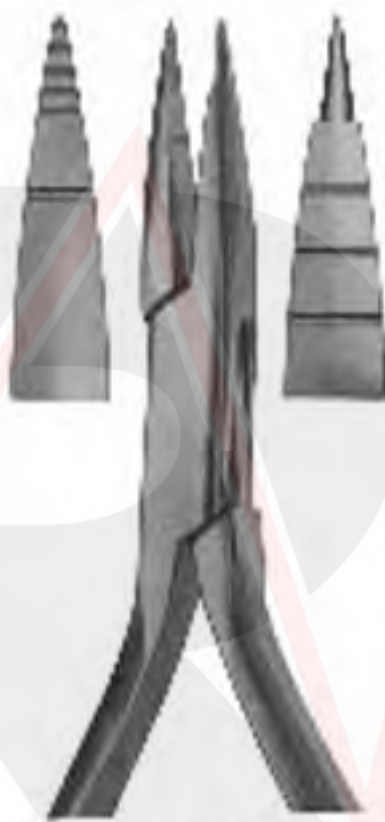

**RP-367**  
**14 cm**



**RP-368**  
**13 cm**



**RP-369**  
**Angle**  
**12.5 cm**



**RP-370**  
**Andersen**  
**14 cm**

0.7 mmØ  
1.0 mmØ

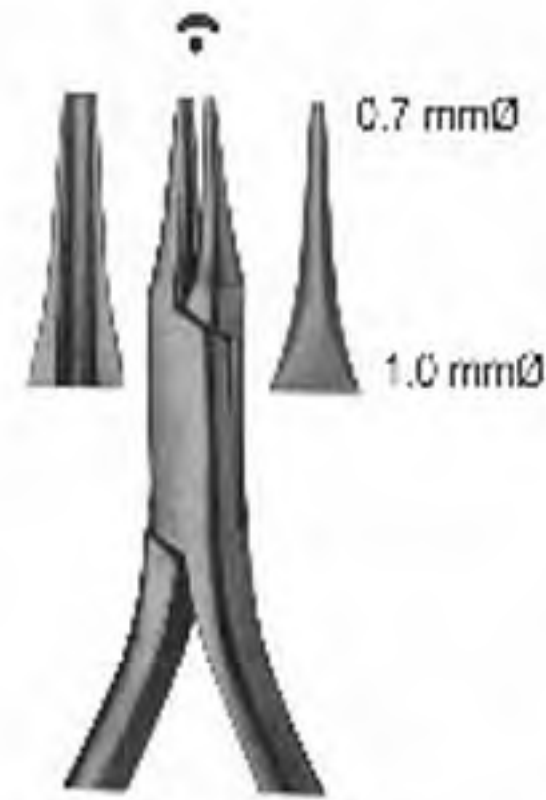

**RP-371**  
**13.5 cm**

0.7 mmØ  
1.0 mmØ



**RP-372**  
**Schwarz**  
**13.5 cm**

0.5 mmØ  
0.7 mmØ



**RP-373**  
**Fischer**  
**13 cm**

0.8 mmØ  
1.0 mmØ



**RP-374**  
**Aderer**  
12 cm



**RP-375**  
**Aderer-Heavy**  
12 cm



**RP-376**  
**Tweed**  
14.5 cm



**RP-377**  
**O.brien**  
**RRm**



**RP-378**  
**Wire bending plier**  
12.5 cm



**RP379**  
**Adams**  
12.5 cm



**RP381**  
**Young**  
14 cm



**RP-380**  
**Frevert**  
12.5 cm



**RP382**  
**Clasp forming**  
14 cm



**Ligature Instruments**

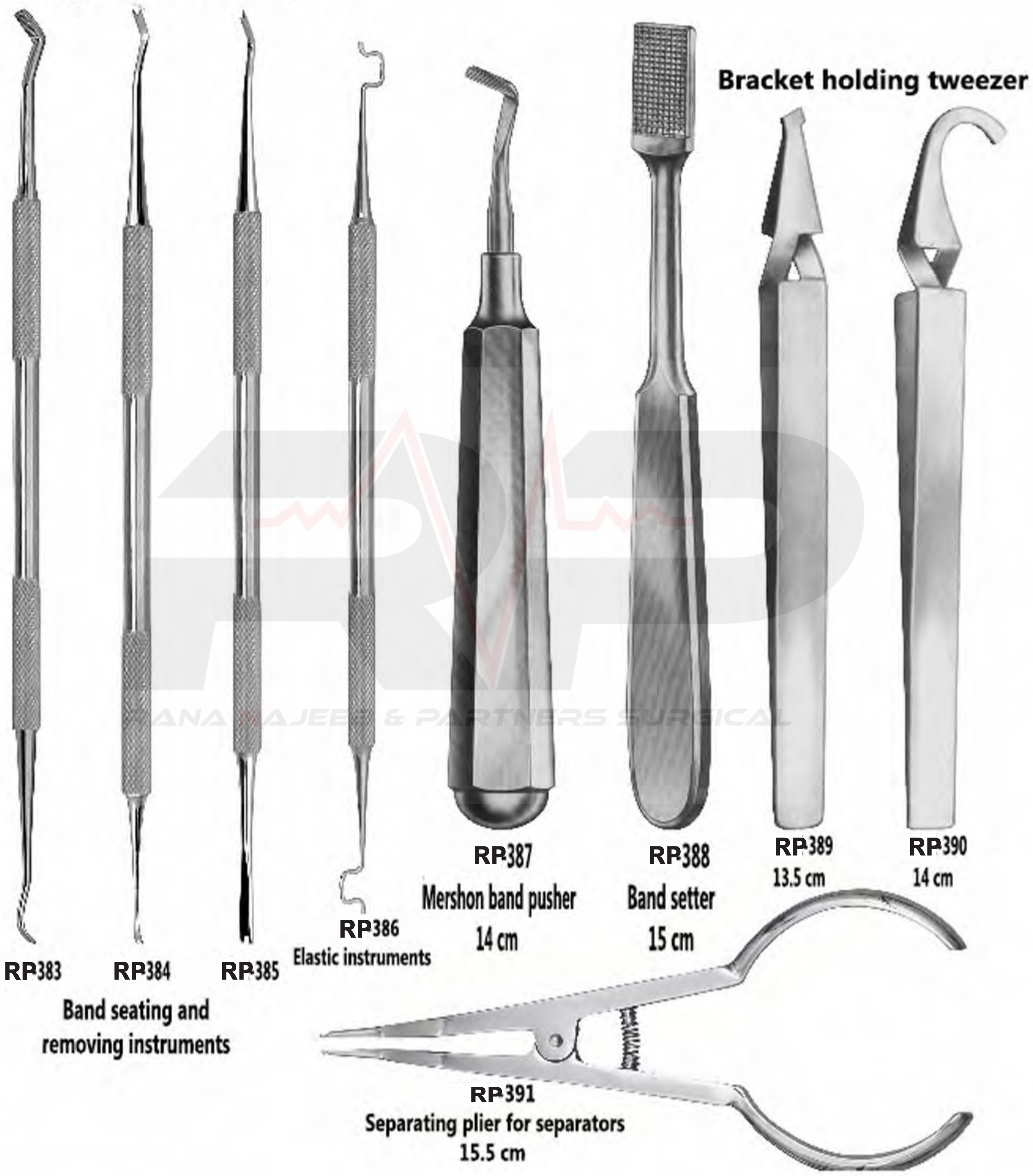

RP383 RP384 RP385

Band seating and removing instruments

RP386 Elastic instruments

RP387 Mershon band pusher 14 cm

RP388 Band setter 15 cm

RP389 13.5 cm

RP390 14 cm

RP391 Separating plier for separators 15.5 cm

Bracket holding tweezer



**RP-392**  
Mathieu plier  
14 cm



**RP393**  
Elastic Ligature placing plier  
14 cm



**RP394**  
Mathieu Ligature plier  
14 cm



**RP396**  
Masquito plier

**RP395**  
Mathieu plier with finger ring  
14 cm



**RP397**  
Bracket Positioning gauge



**RP398**  
Bracket placing  
tweezer



**RP399**  
Bracket placing  
tweezer



**RP400**  
Ligature tying  
plier



**RP401**  
Bracket holding  
tweezer



**RP402**  
Band seating  
instruments nylon



**RP403**  
Masquito forceps



**RP-405**  
**Fig-2**  
**12 cm**  
**Curved**



**RP-407**  
**Fig-2**  
**13 cm**  
**Goldman fox**  
**Saw edge**  
**Curved**

**RP-404**  
**Fig-1**  
**12 cm**  
**Straight**

**RP-406**  
**Fig-1**  
**13 cm**  
**Goldman fox**  
**Saw edge**  
**Straight**



**RP-408**  
**Fig-1**  
**11.5 cm**  
**Iris**  
**Curved**

**RP-409**  
**Fig-2**  
**11.5 cm**  
**Iris**  
**Curved**

**RP-410**  
**Fig-3**  
**11.5 cm**  
**Iris**



**RP-411**  
**Fig-1**  
**11.5 cm**  
**Angular**

**RP-412**  
**Fig-2**  
**11.5 cm**  
**Angular**

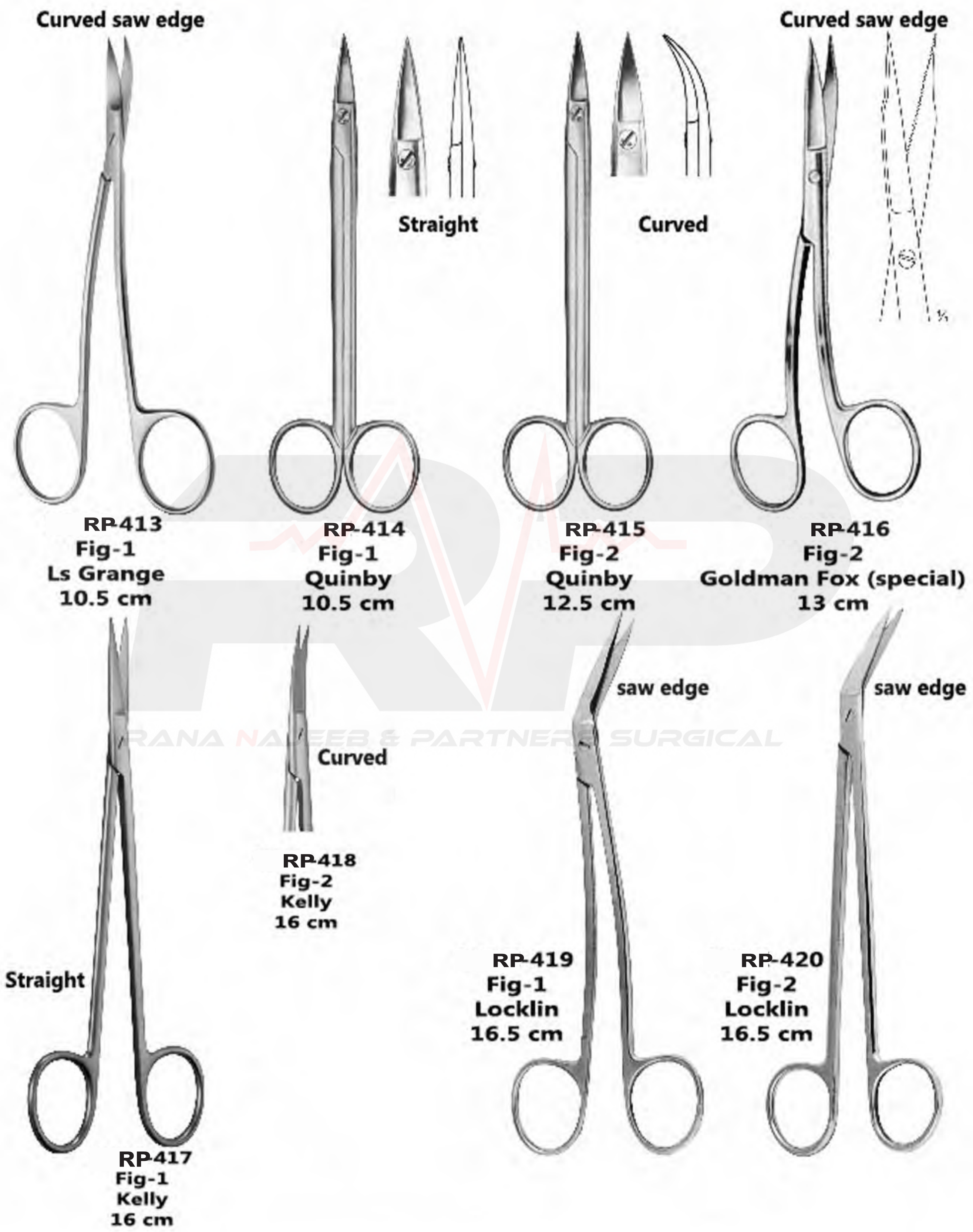

Very fine points



**RP-421**  
Fig-1  
Nylon (Castroviejo)  
12 cm

Very fine points



**RP-422**  
Fig-1  
14.2 cm

Blunt points



**RP-423**  
Fig-1  
Westcott  
11 cm

Sharp points



**RP-424**  
Fig-2  
Westcott  
11 cm

RANA NAJEEB & PARTNERS SURGICAL

Curved saw edge



**RP-425**  
Fig-1  
Spencer  
9 cm



**RP-426**  
Fig-1  
Spencer  
13 cm



**RP-427**  
Fig-1  
Neumann  
12.5 cm



**RP-428**  
Fig-1  
Dean  
17 cm

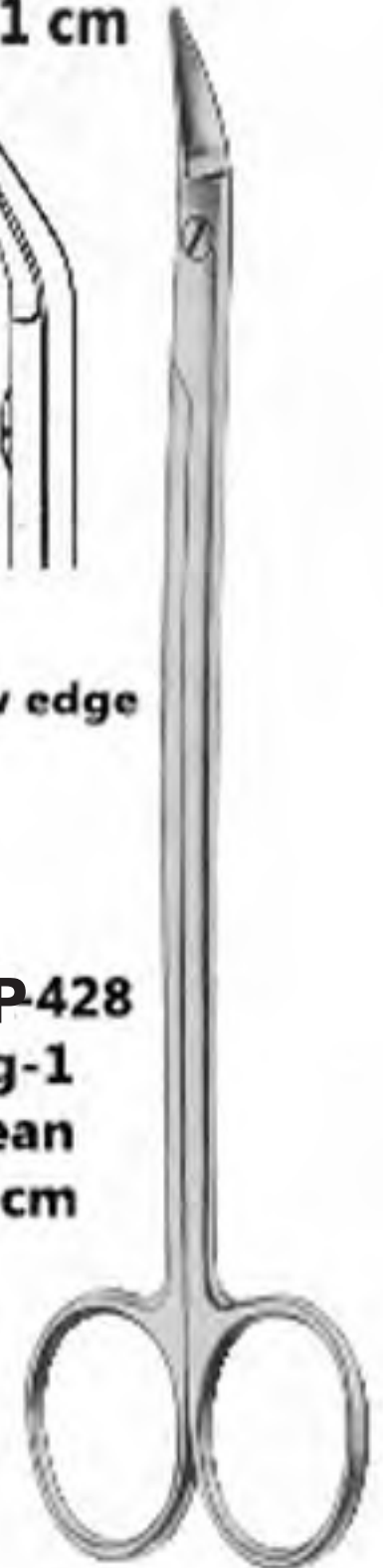



**RP-429**  
**Fig-1**  
**Mayo**



**RP-430**  
**Fig-2**  
**Mayo**

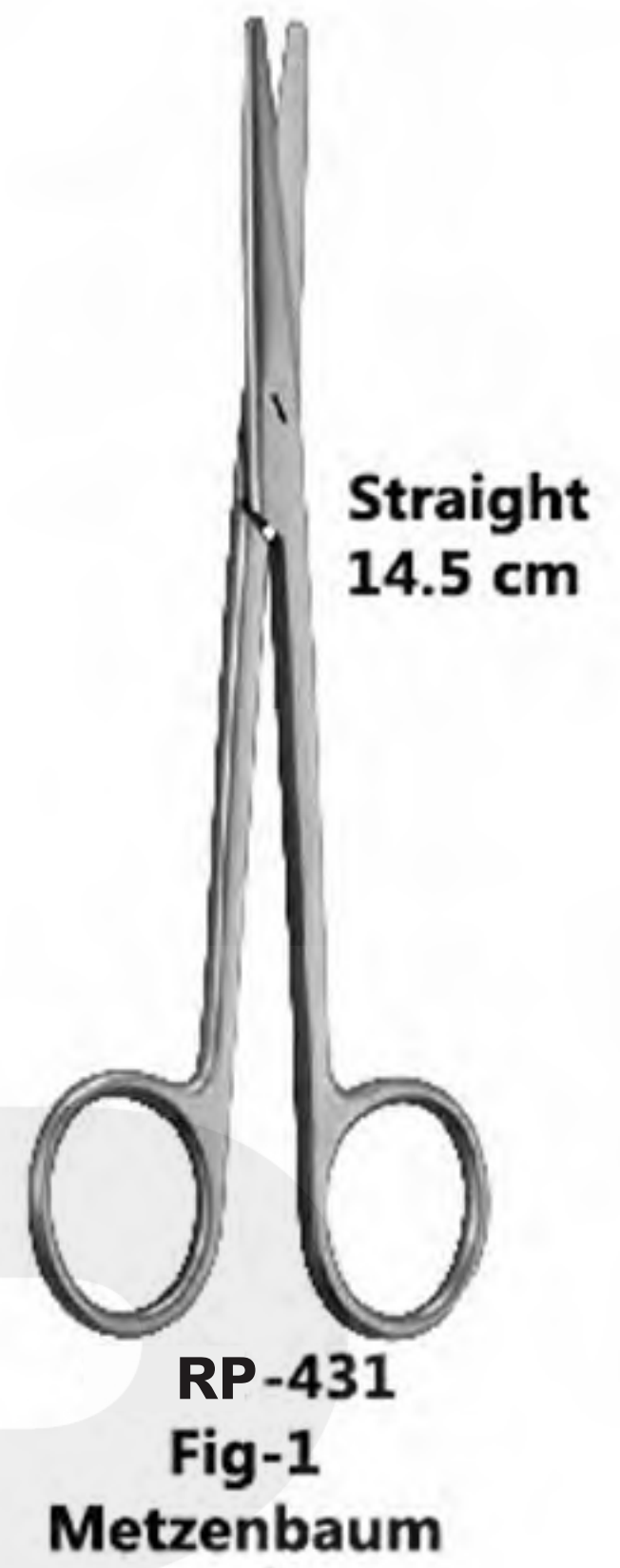

**RP-431**  
**Fig-1**  
**Metzenbaum**



**RP-432**  
**Fig-2**  
**Matzenbaum**



**RP-433**  
**Fig-1**  
**Matzenbaum-Delicate**

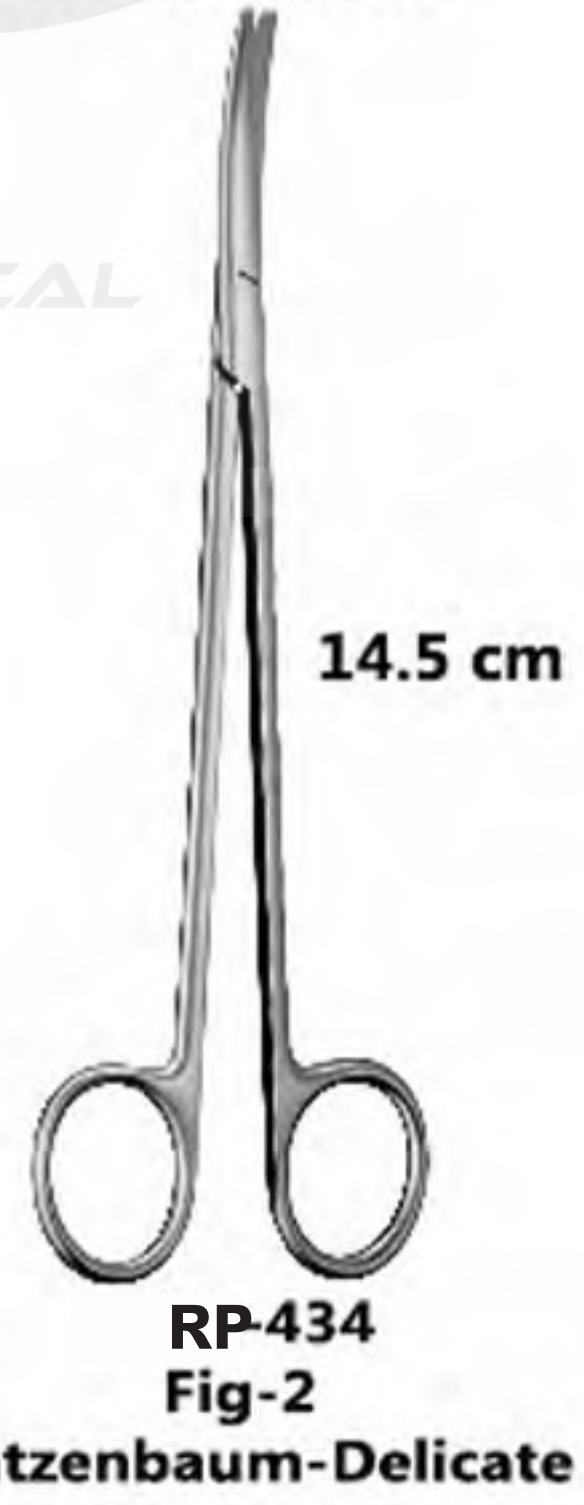

**RP-434**  
**Fig-2**  
**Matzenbaum-Delicate**

RANA NAJEEB & PARTNERS SURGICAL

# HAEMOSTATIC FORCEPS

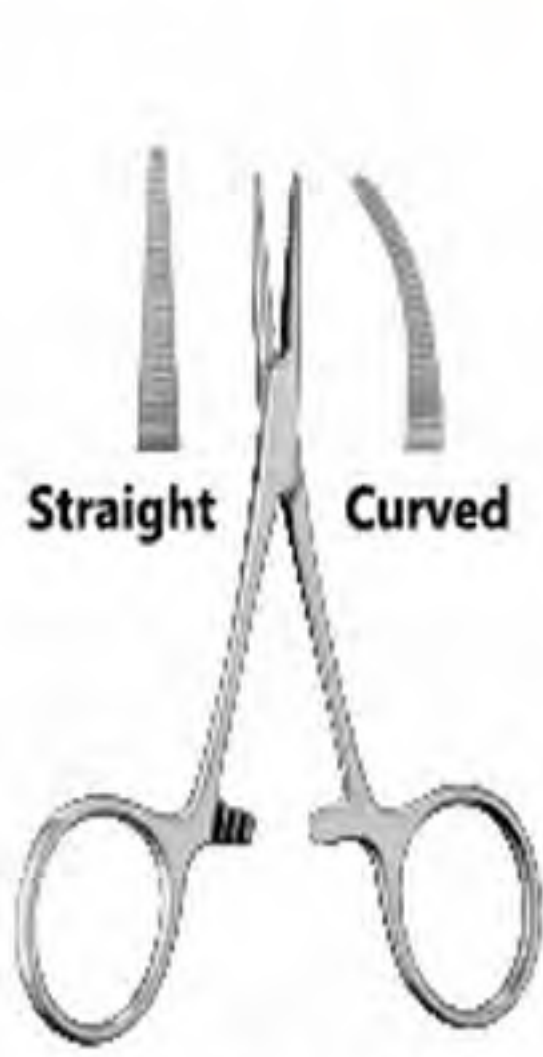

**RP-435**  
Baby-Masquito  
10 cm

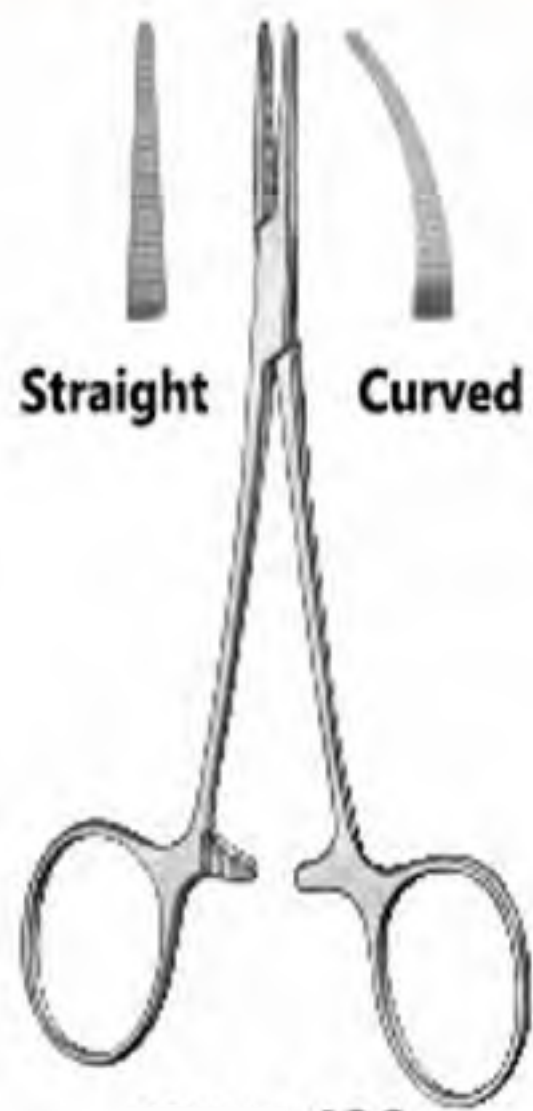

**RP-436**  
Micro-Halsted  
12.5 cm

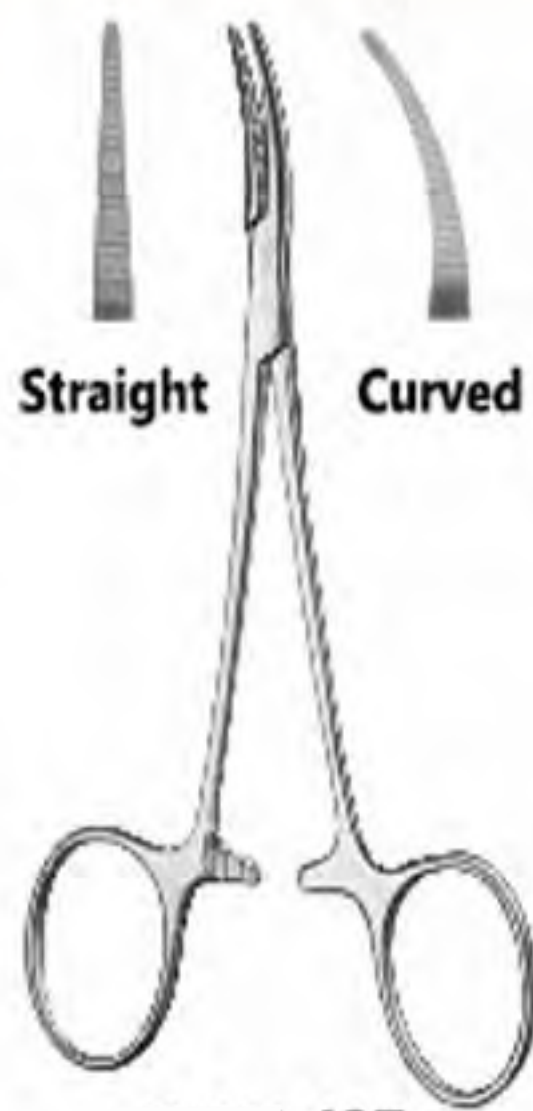

**RP-437**  
Halsted-Masquito  
12.5 cm

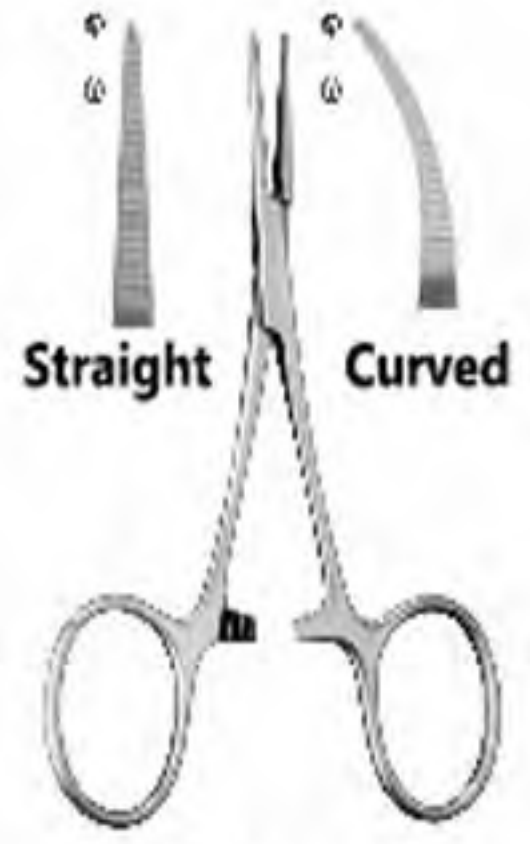

**RP-438**  
Baby-Masquito  
10 cm

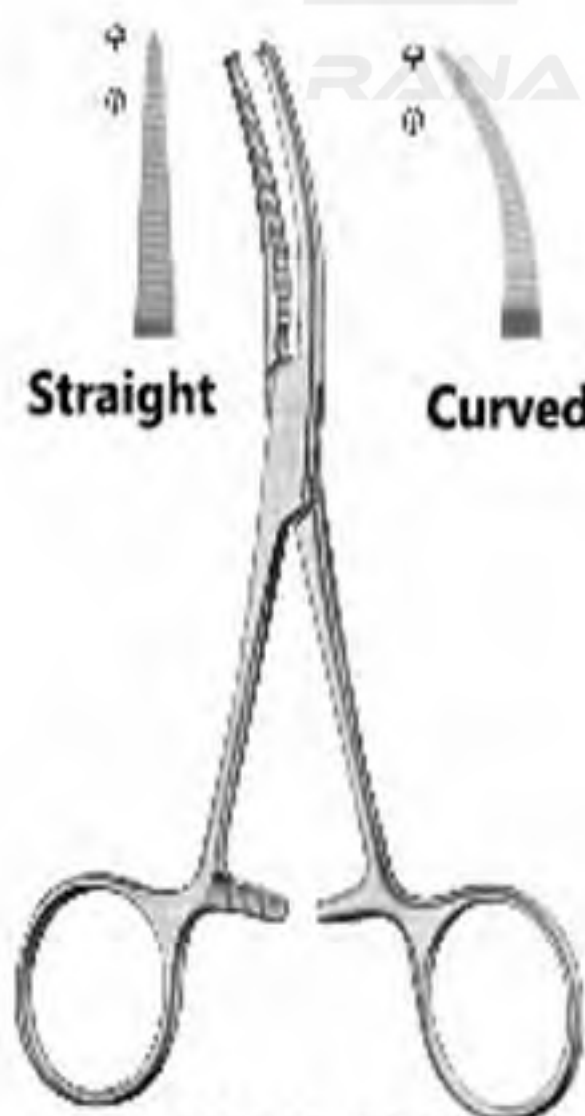

**RP-439**  
Micro-Halsted  
12.5 cm

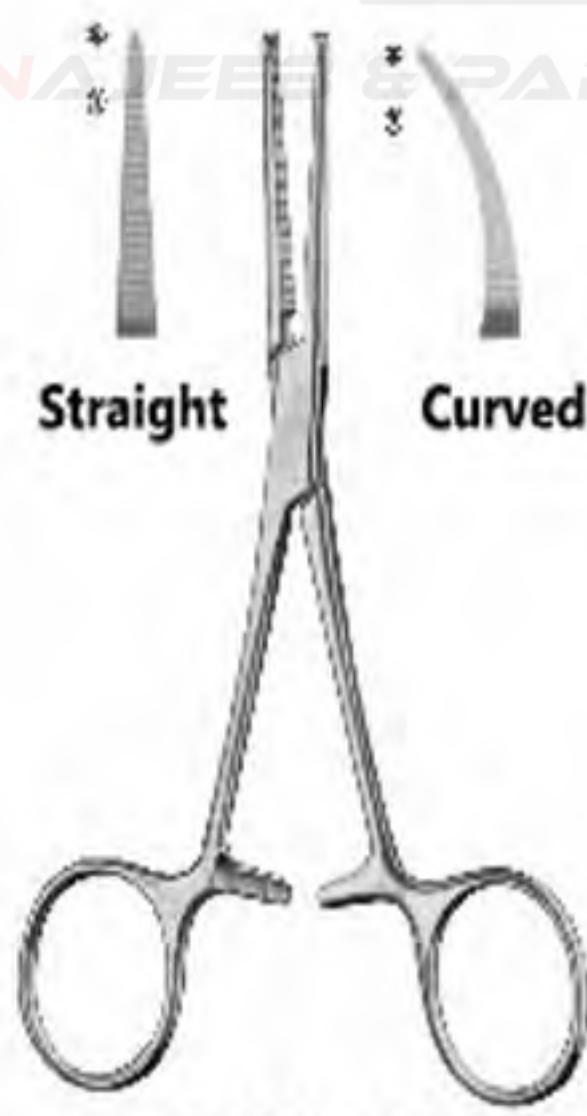

**RP-440**  
Micro-Halsted  
12.5 cm



**RP-441**  
Pean  
12.5 cm

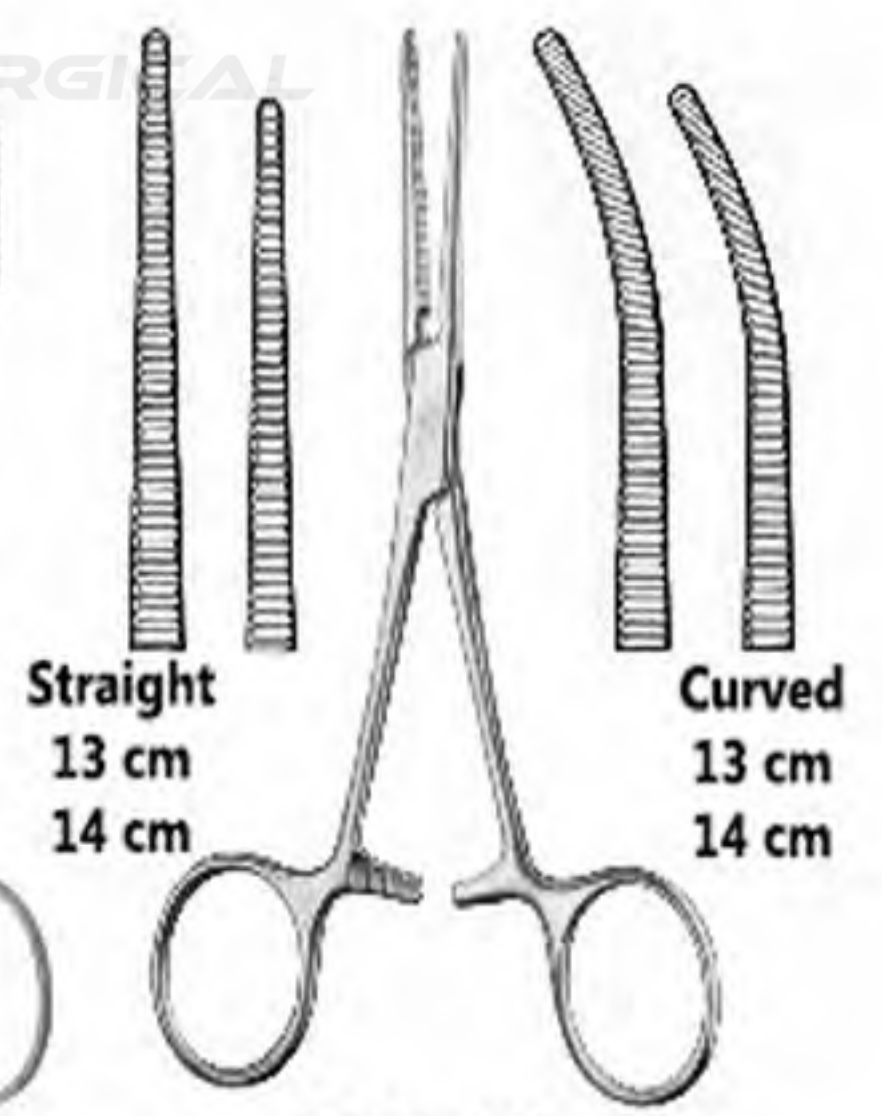

**RP-442**  
Pean  
13 cm

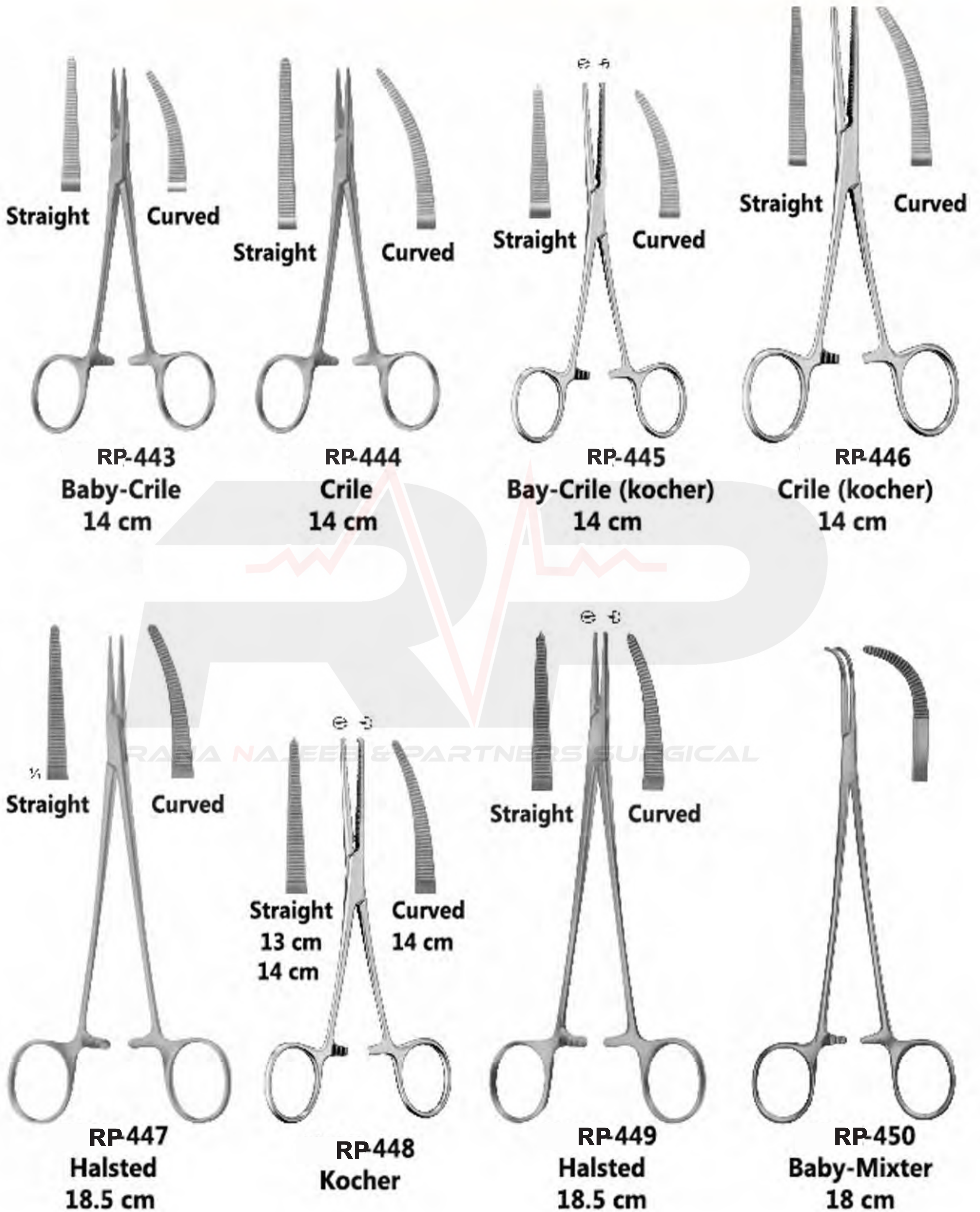





**RP451**  
Without Ratchet  
14.5 cm



**RP452**  
With Ratchet  
14.5 cm



**RP453**  
Curved  
17.5 cm



**RP454**  
Curved  
21 cm

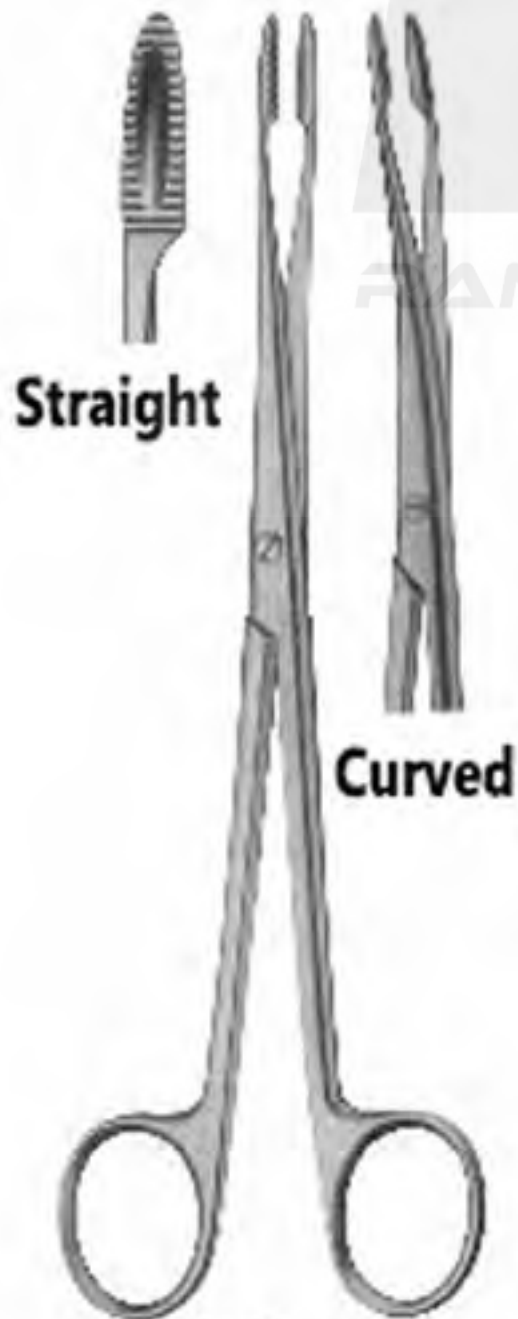

**RP455**  
Without Ratchet  
18 cm

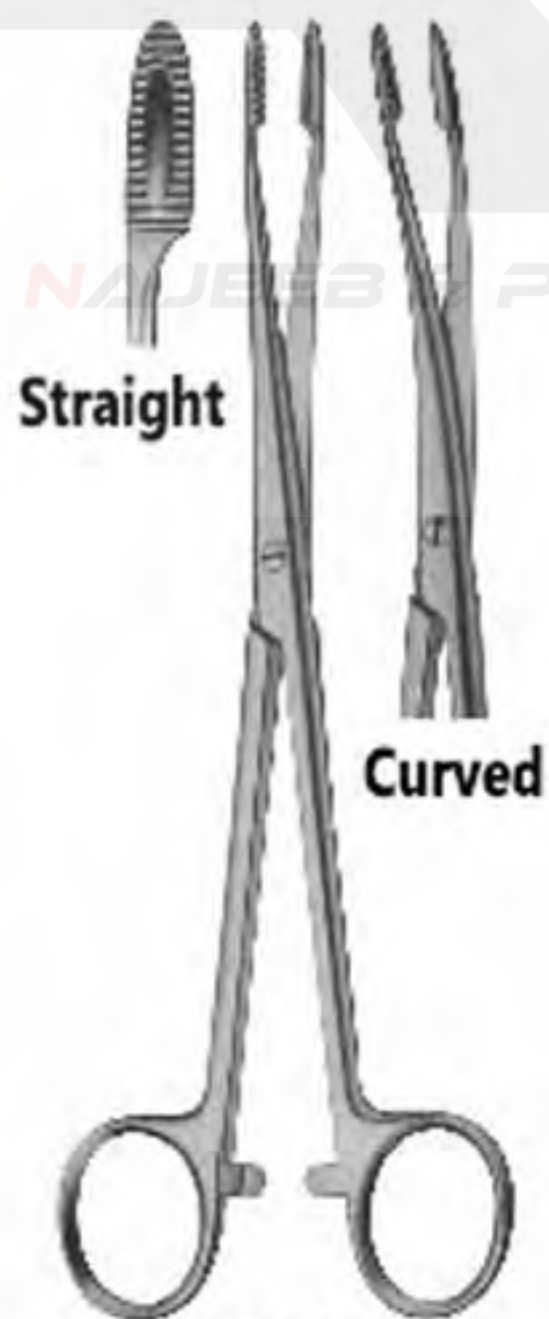

**RP456**  
With Ratchet  
18 cm

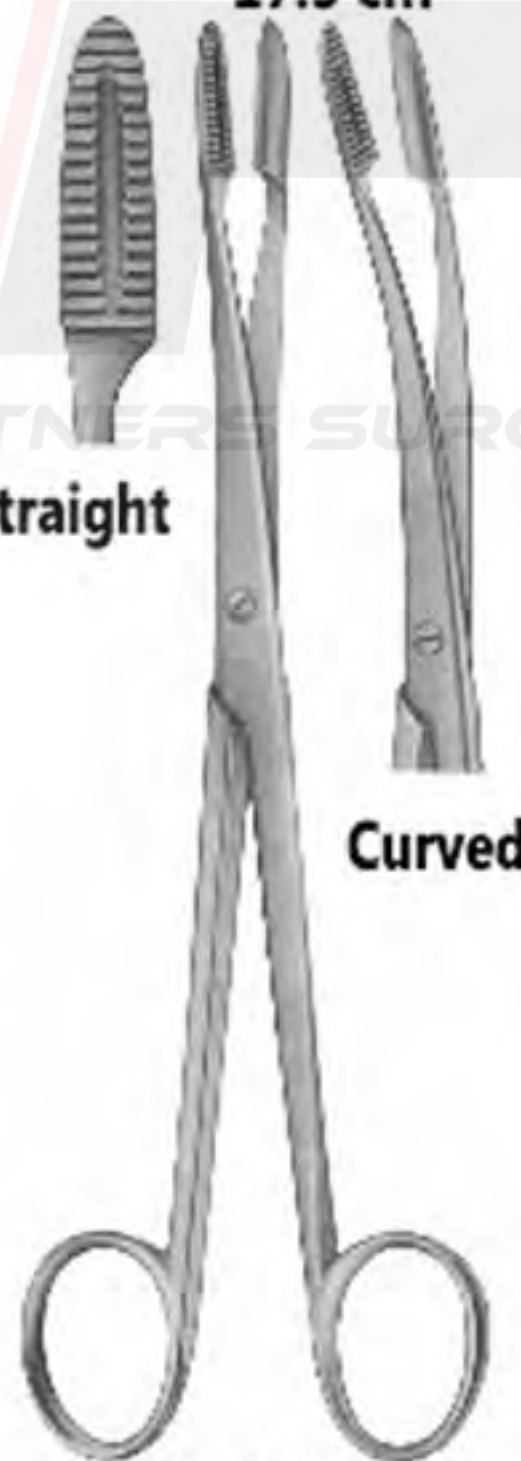

**RP457**  
Without Ratchet  
20 cm

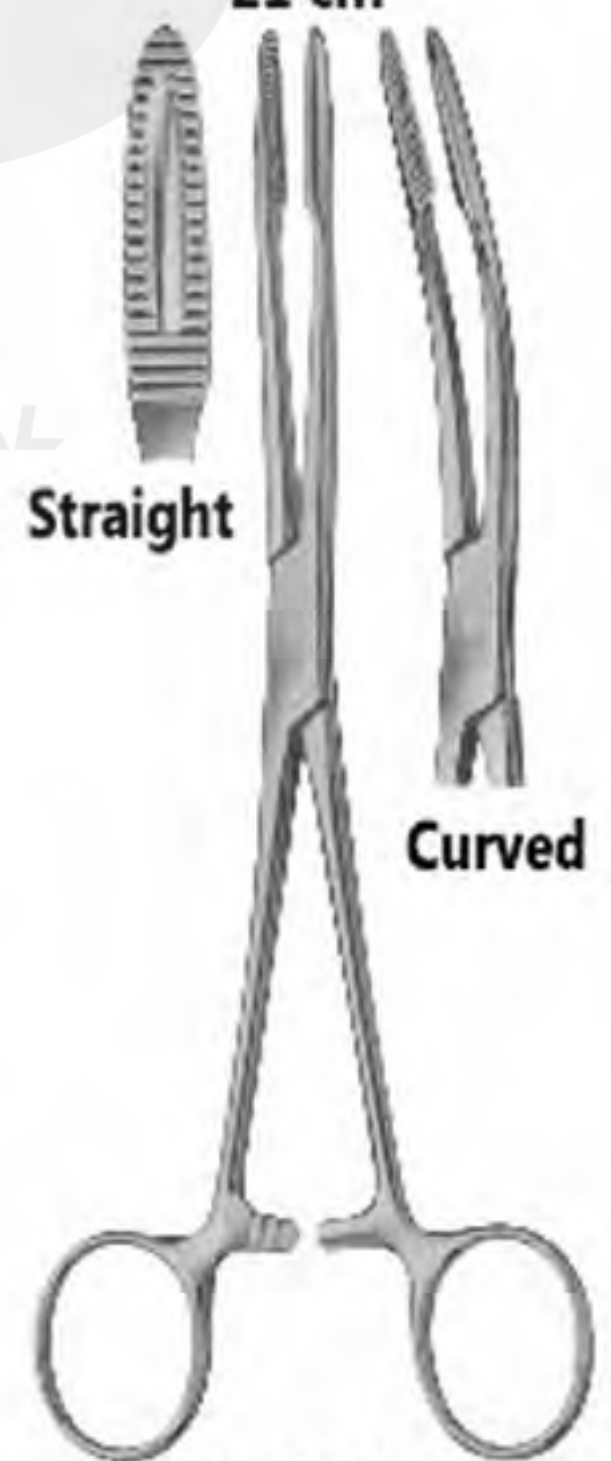

**RP458**  
With Ratchet  
20 cm

# NEEDLE HOLDERS



**RP-459**  
**Baumgartner**  
14.5 cm



**RP-460**  
**Crile-Murray**  
15 cm

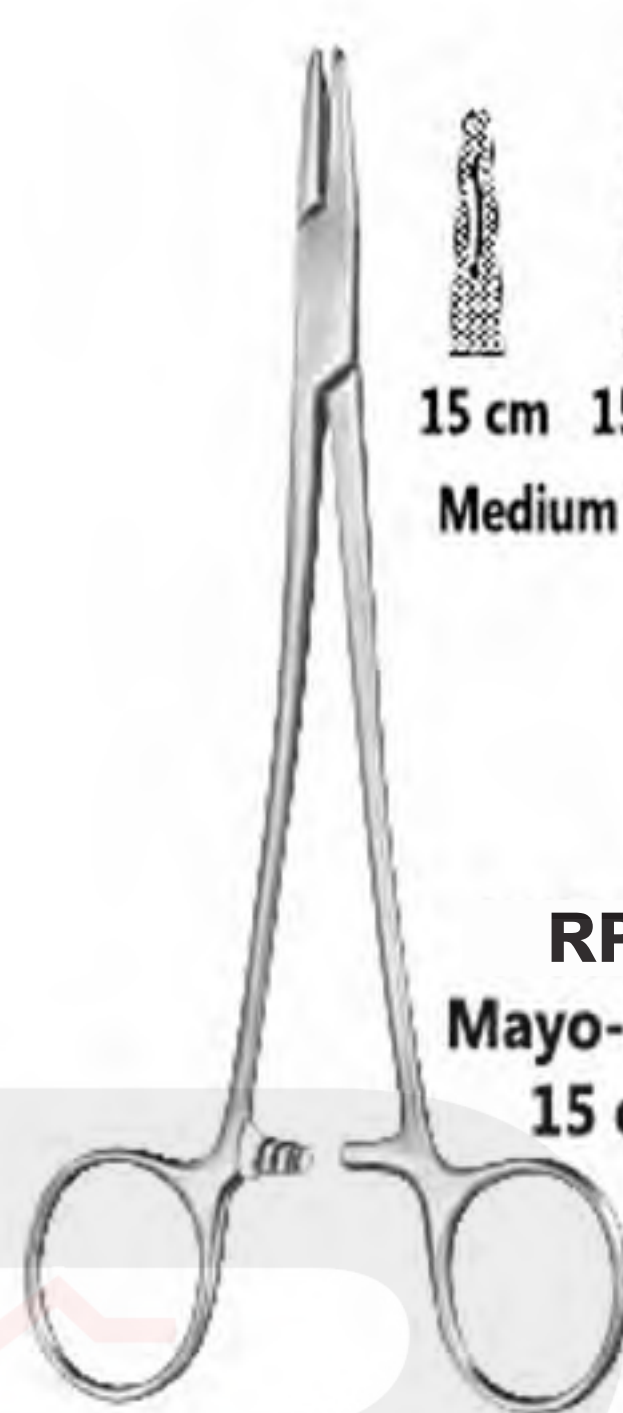

15 cm 15 cm 20 cm  
Medium Fine Pattern

**RP-461**  
**Mayo-Hegar**  
15 cm



**RP-462**  
**Adson**  
17.5 cm

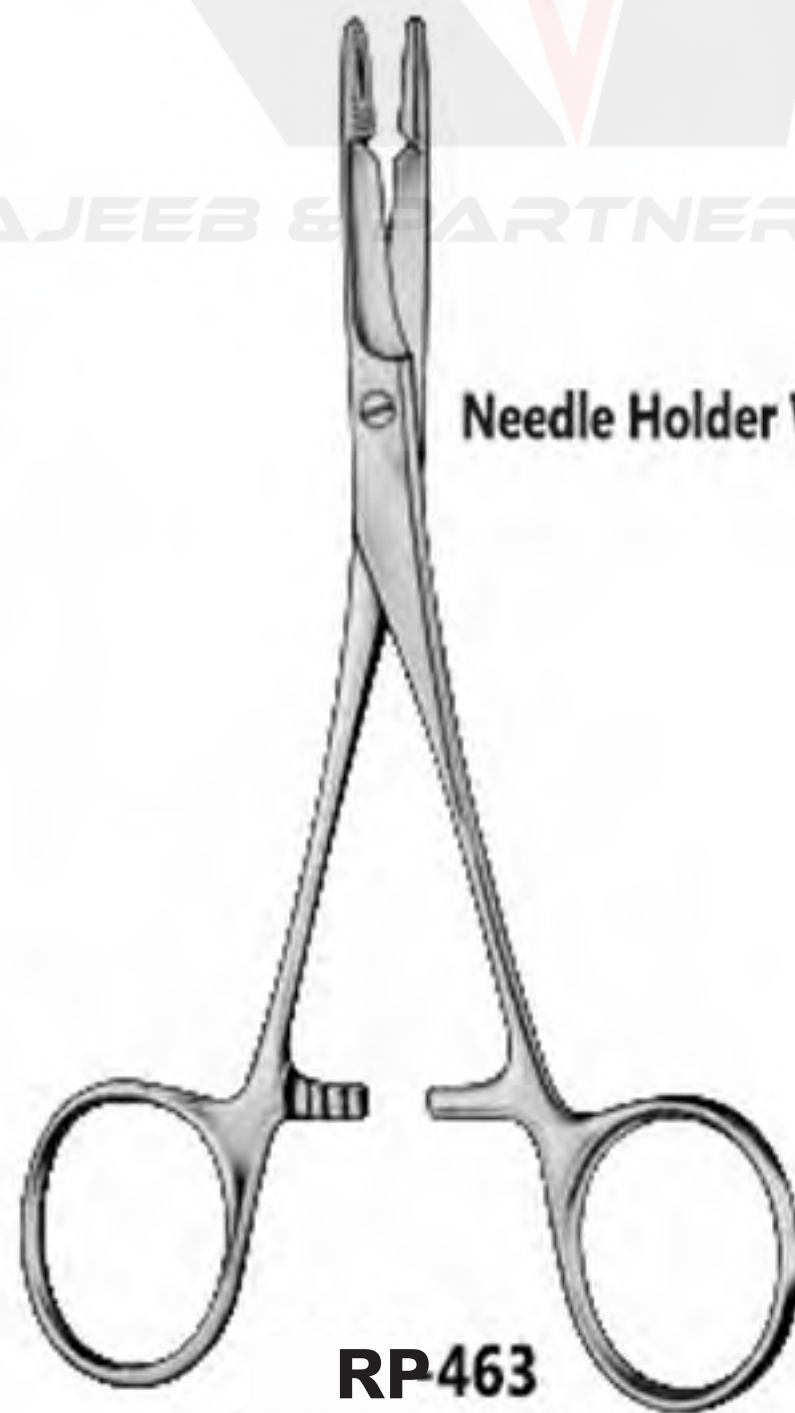

**RP-463**  
**Hegar-Olsan**  
14 cm

Needle Holder With Scissors



**RP-464**  
**Gillies**  
15 cm

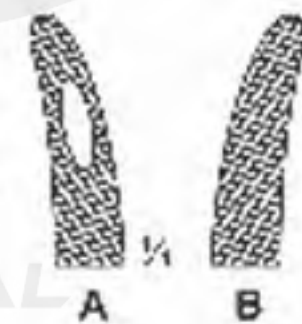



**RP-465**  
**Mathieu**  
**14 cm**



**RP-466**  
**Mathieu**  
**14 cm**



**RP-467**  
**Boynton**  
**12 cm**



**RP-468**  
**Castroviejo**  
**14 cm**



**RP-469**  
**Castroviejo**  
**14 cm**



**RP-470**  
**Castroviejo**  
**13 cm**



**RP-471**  
**Arruga**  
**16 cm**

RANA NAJEEB & PARTNERS SURGICAL

Curved

Straight

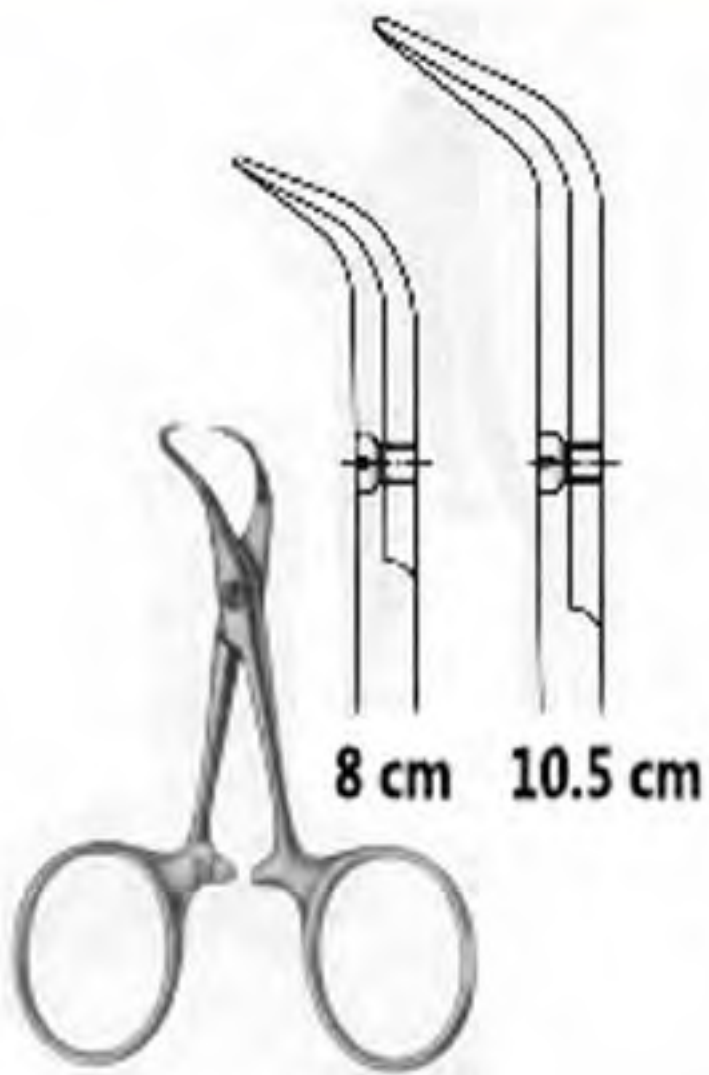

**RP-472**  
**Backhuas**

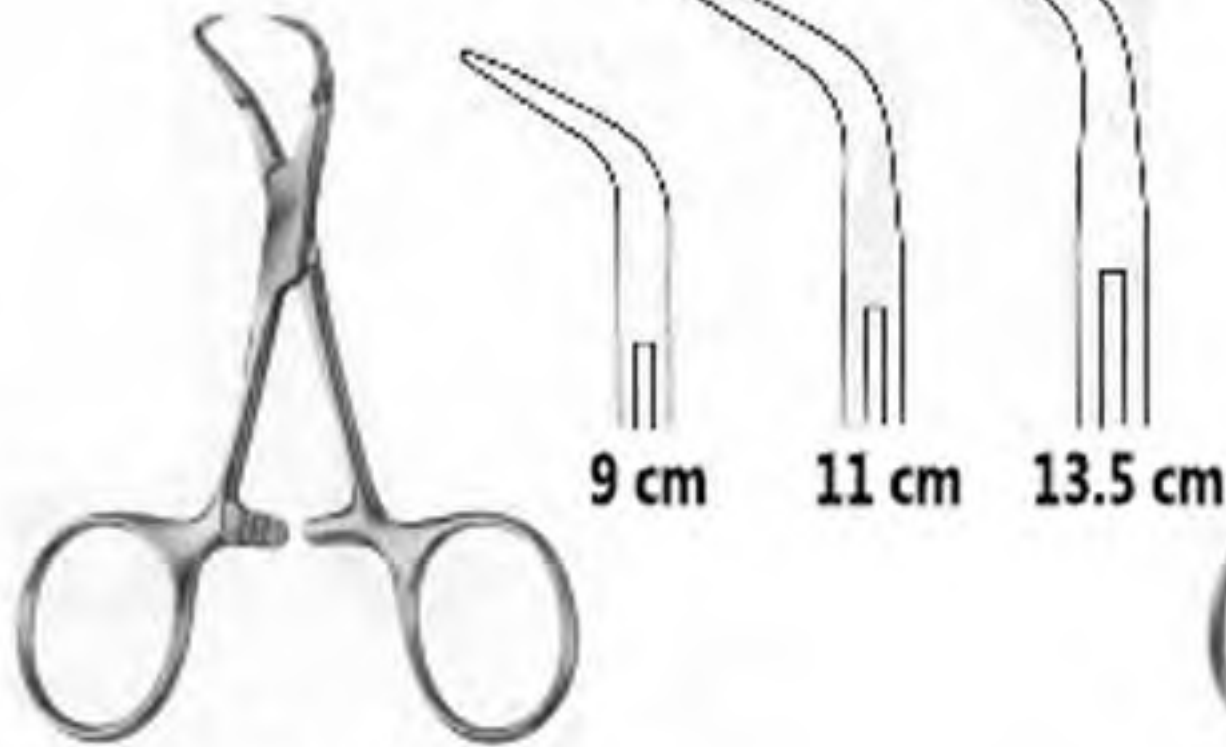

**RP-473**  
**Backhuas**



**RP-474**  
**Backhuas-Kocher**  
**13.5 cm**



**RP-475**  
**16 cm**



**RP-476**  
**Cheattle**  
**28 cm**



**RP-477**  
**Cheattle**  
**20 cm**



**30 cm**



**RP-478**  
**20 cm**  
**30 cm**



**RP-479**  
**Rogge**  
**20.5 cm**



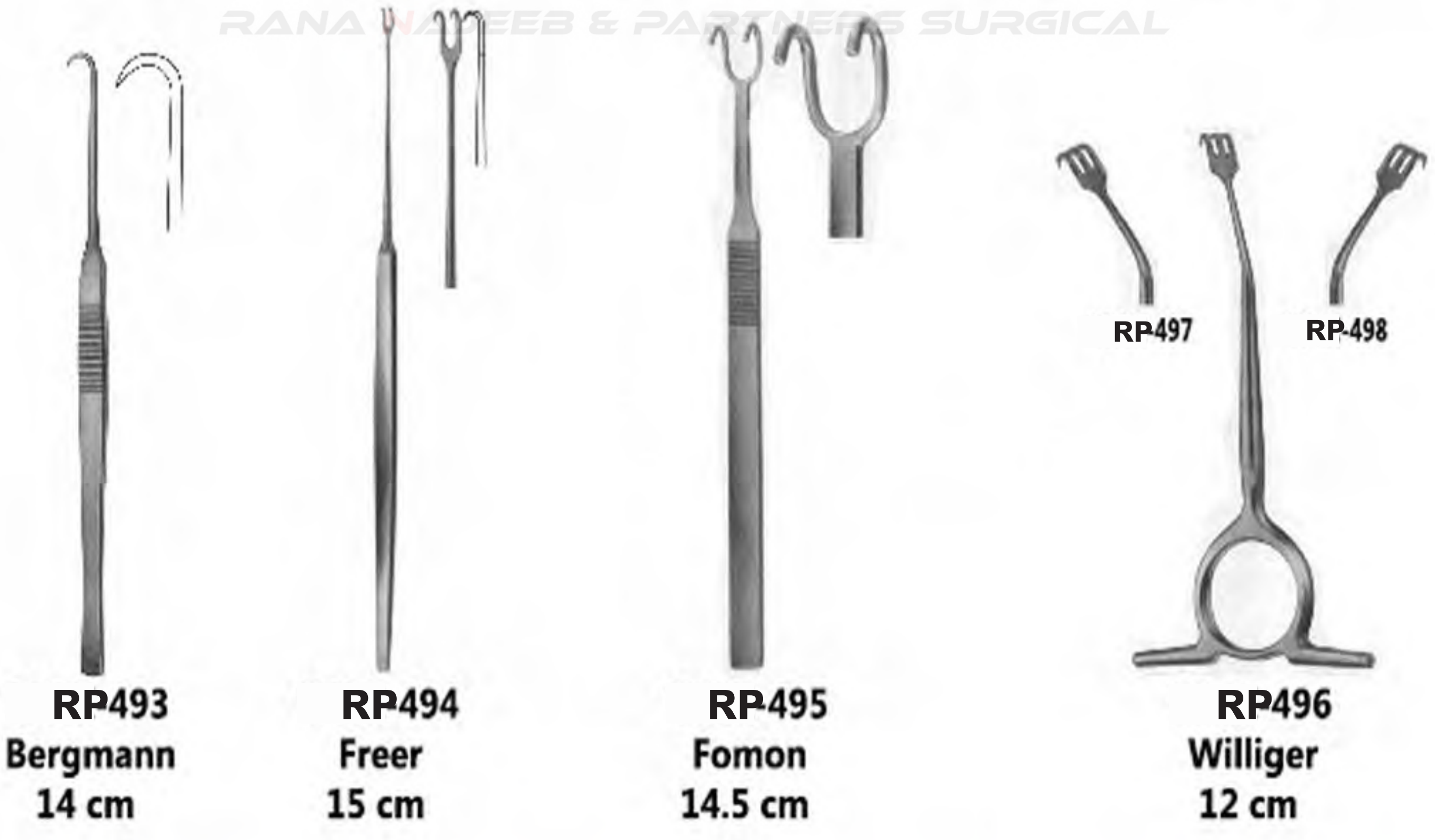
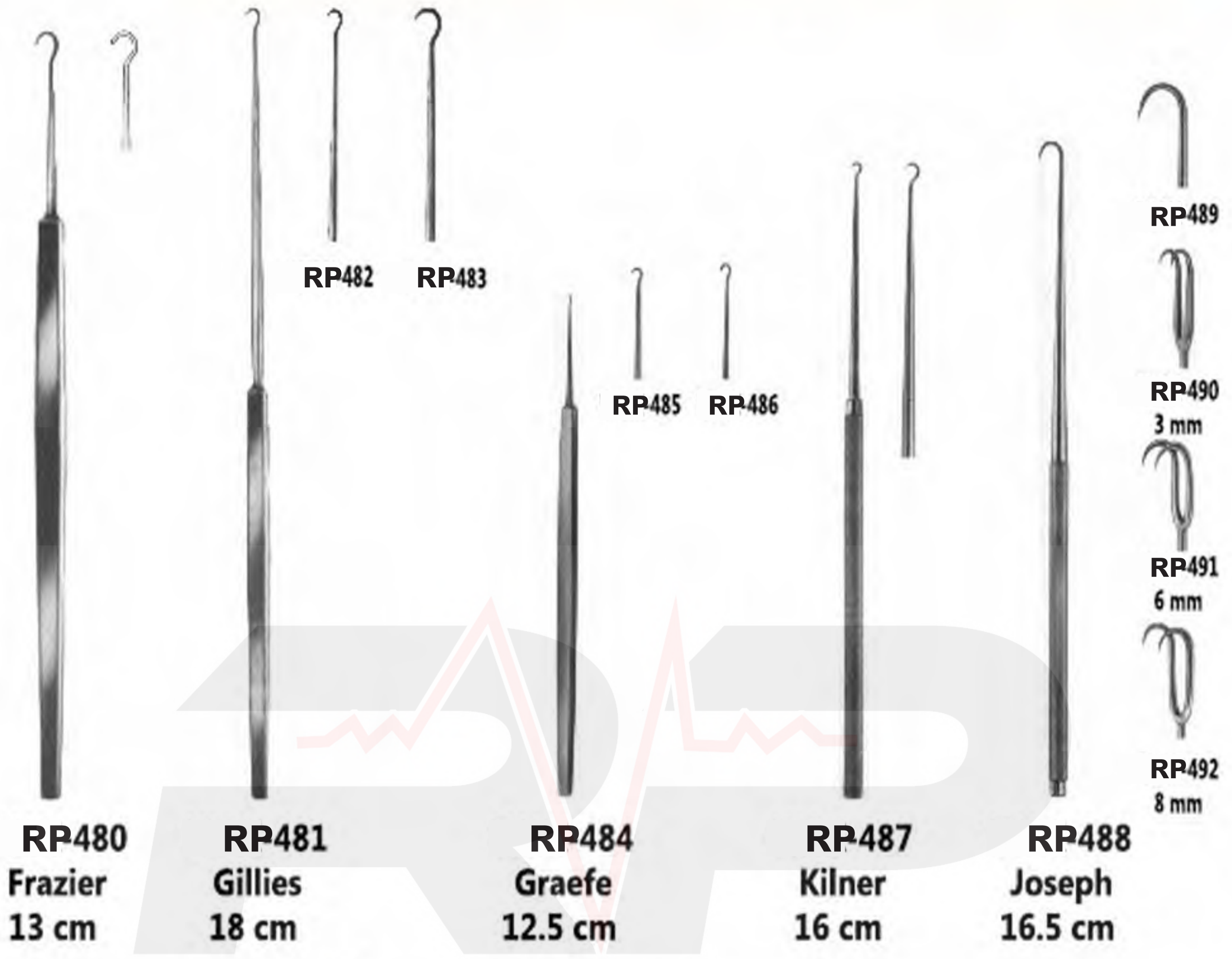

# RETRACTORS

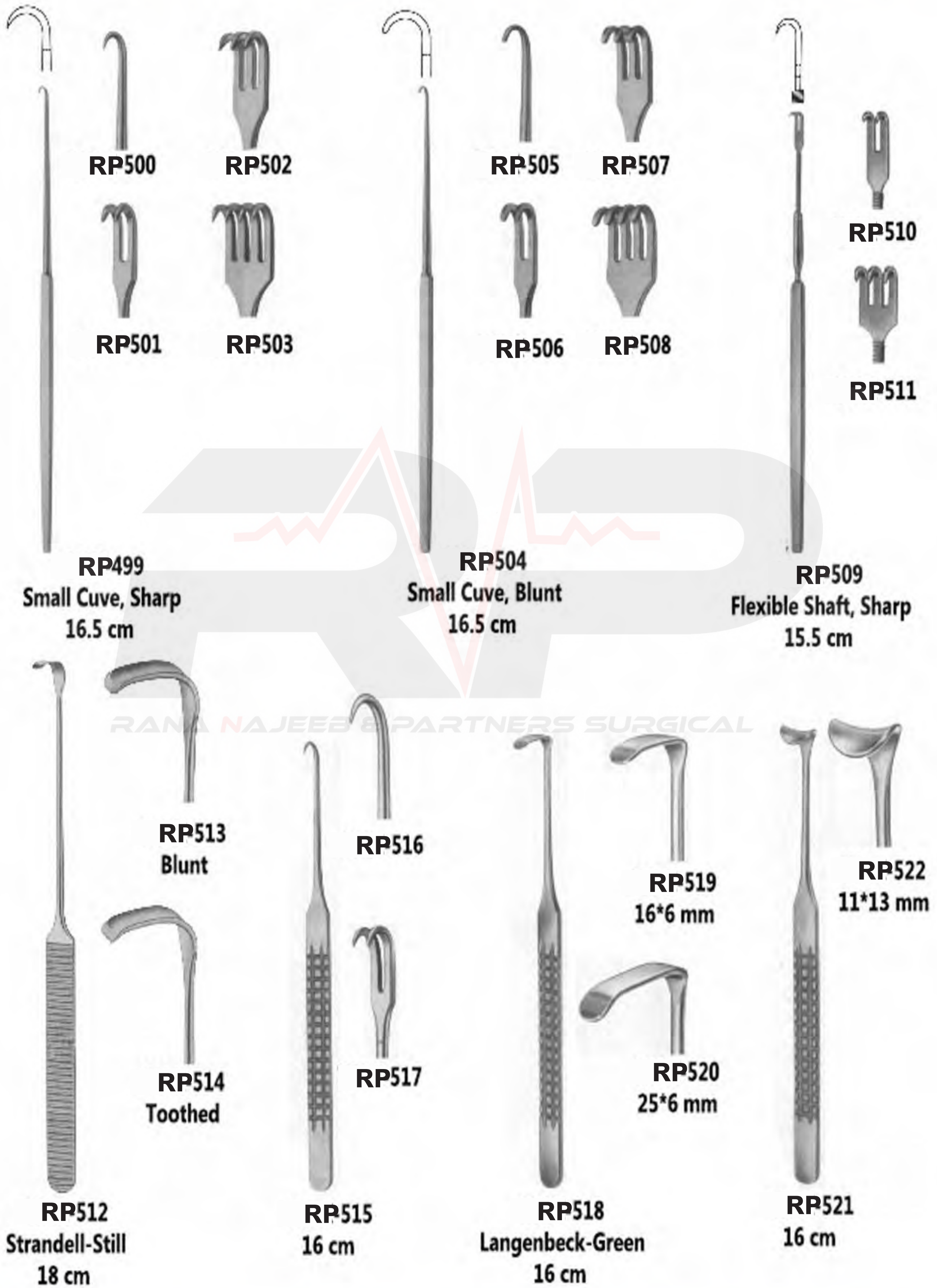

25\*10 mm  
22\*10 mm



28\*12 mm  
32\*12 mm  
**RP523**  
Farabeuf  
12.5 cm



**RP529**  
30\*10 mm



**RP530**  
40\*10 mm



**RP531**  
43\*13 mm

23\*16 mm  
20\*16 mm



**RP524**  
Farabeuf  
15 cm



**RP529**  
Langenbeck  
23 cm

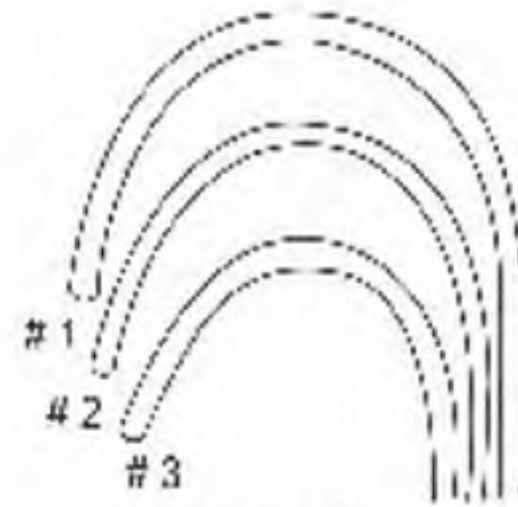

**RP525**  
Foux-Set  
Consisting of  
15 cm

- RP526** 19\*22 mm  
23\*30 mm
- RP527** 25\*26 mm  
28\*38 mm
- RP528** 28\*29 mm  
33\*45 mm

29 mm  
26 mm  
22 mm



28 mm  
38 mm  
45 mm



**RP532**  
25\*6 mm



**RP533**  
35\*8 mm



**RP534**  
35\*11 mm



**RP535**  
35\*15 mm

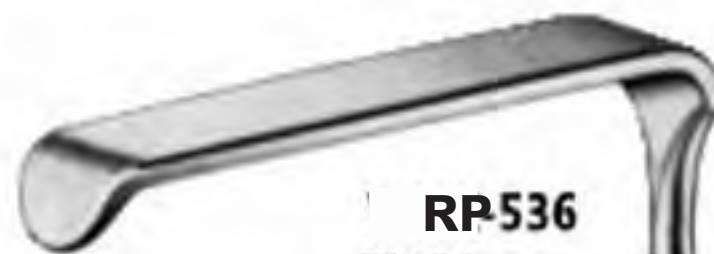

**RP536**  
41\*11 mm



**RP537**  
55\*11 mm



**RP532**  
Langenbeck  
21.5 cm

# CHEEK RETRACTORS



**RP538**  
Middeldorpf



**RP538**  
15\*15 mm  
22 cm



**RP539**  
20\*22 mm  
21.5 cm



**RP540**  
28\*28 mm  
23.5 cm



**RP541**  
Greene  
22.5 cm



**RP542**  
Buche  
20.5 cm



**RP543**  
Lengenbeck  
21 cm



**RP543**  
28\*10 mm



**RP544**  
28\*14 mm



**RP545**  
33\*14 mm



**RP546**  
28\*16 mm

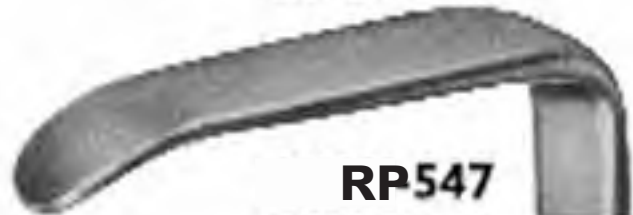

**RP547**  
40\*10 mm



**RP548**  
45\*10 mm



**RP549**  
Kocher  
21 cm



28\*8 mm



**RP550**  
Alm  
7 cm



Sharp  
Blunt



**RP551**  
Alm  
10 cm

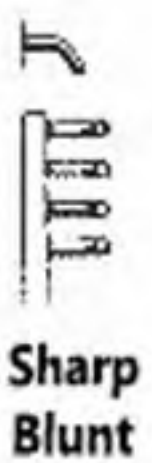

Sharp  
Blunt



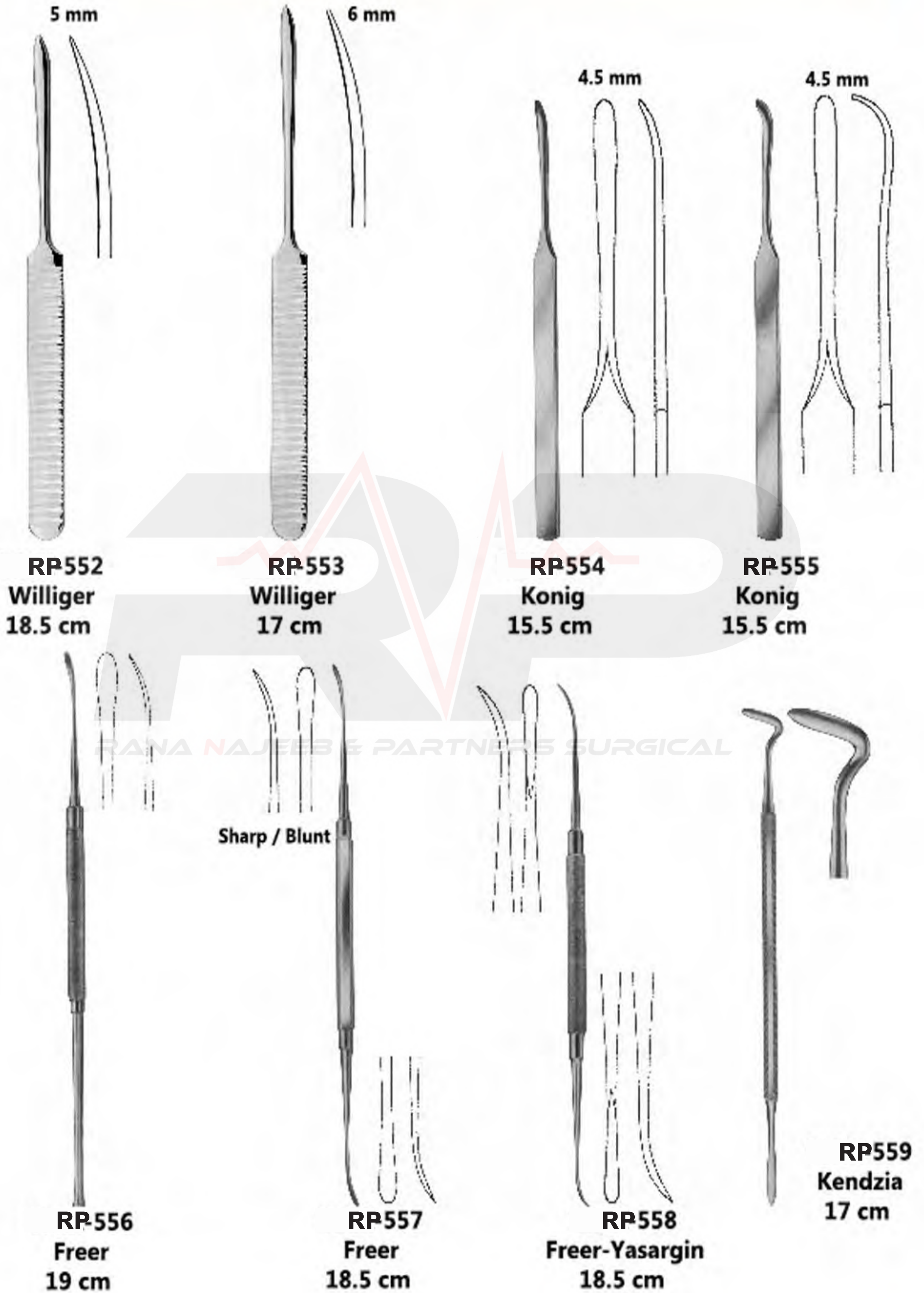

# RASPATORIES

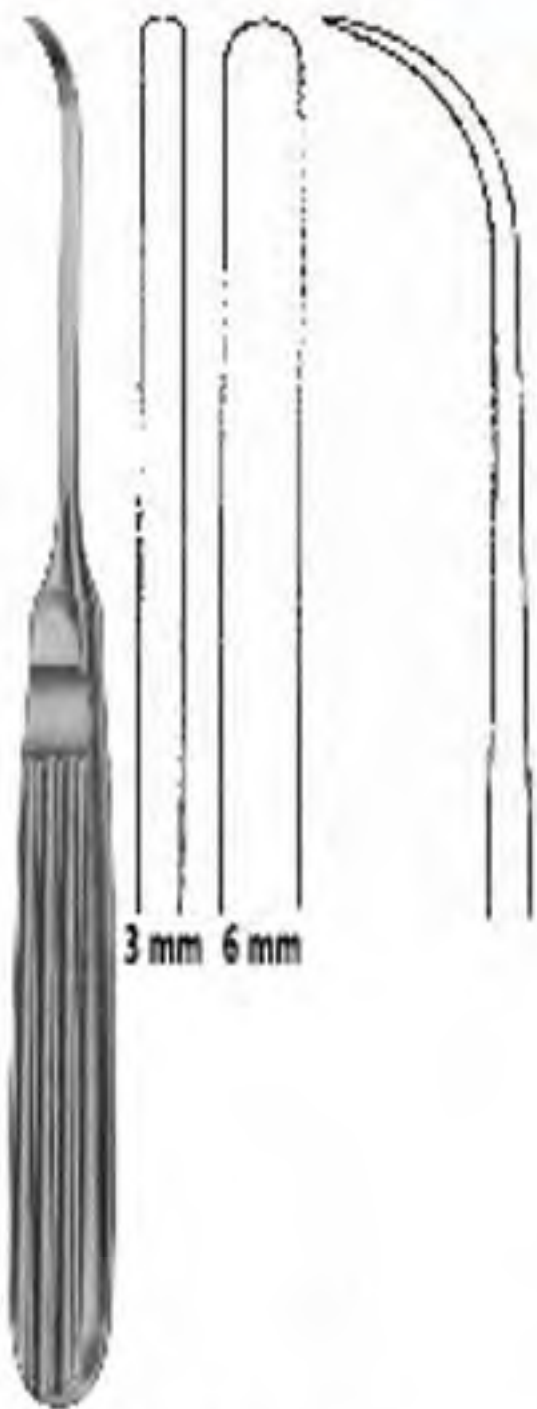

**RP560** 3 mm  
**RP561** 6 mm  
17 cm

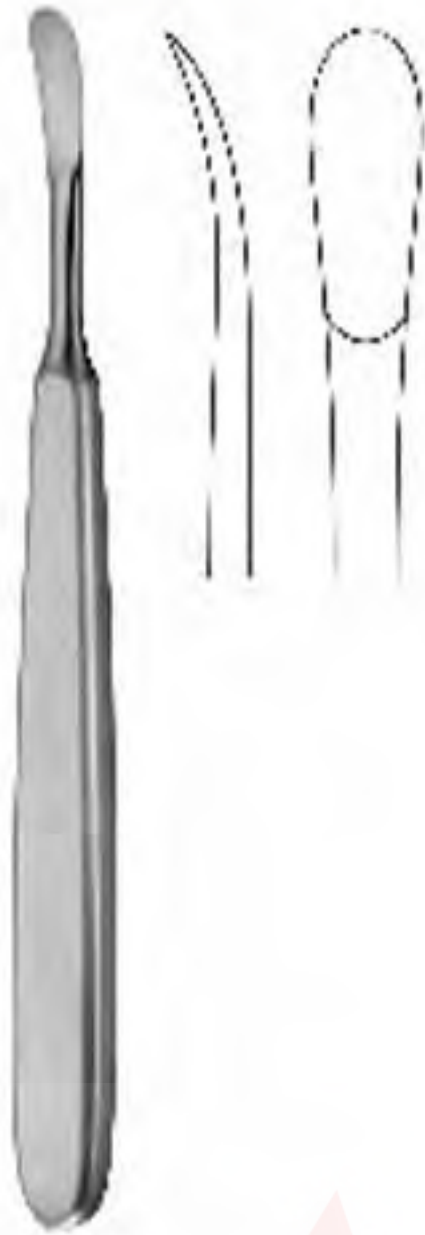

**RP562** 6 mm  
Trelat  
14 cm



**RP563**  
Konig  
15.5 cm



**RP564**  
Williger  
14 cm



**RP565**  
Williger  
16 cm



**RP566** 6 mm  
16.5 cm  
**RP567** 6 mm  
**RP568** 8 mm

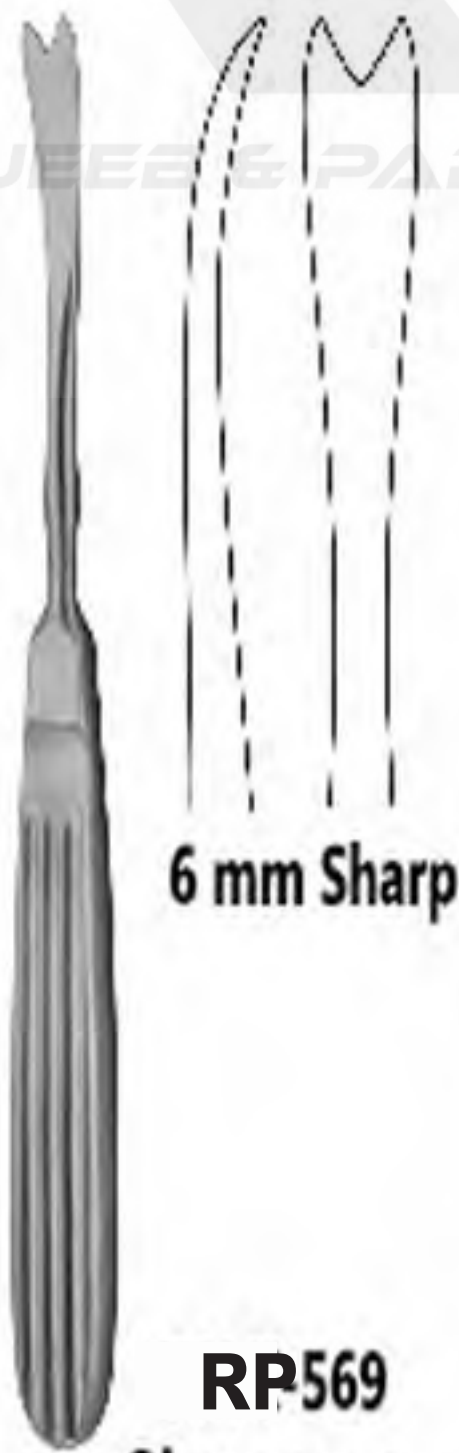

**RP569**  
Obwergeser  
8 mm



**RP570**  
5 mm  
20 cm



**RP571**  
5 mm

**RP572**  
8 mm



**RP573**  
Tessier  
22 cm

6 mm  
Bone Curette

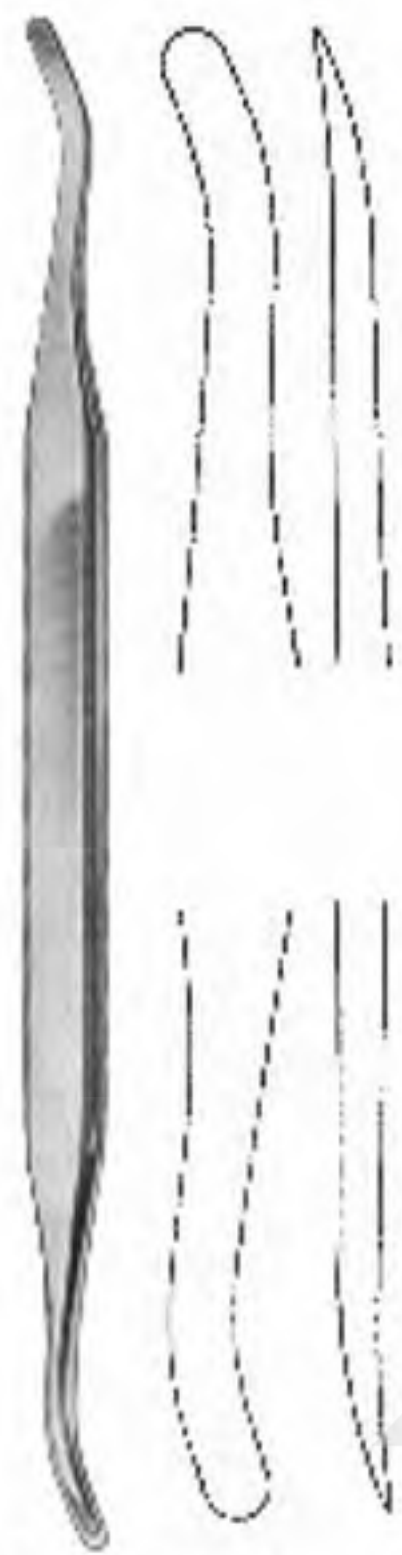

**RP574**  
**Scladin**  
19.5 cm

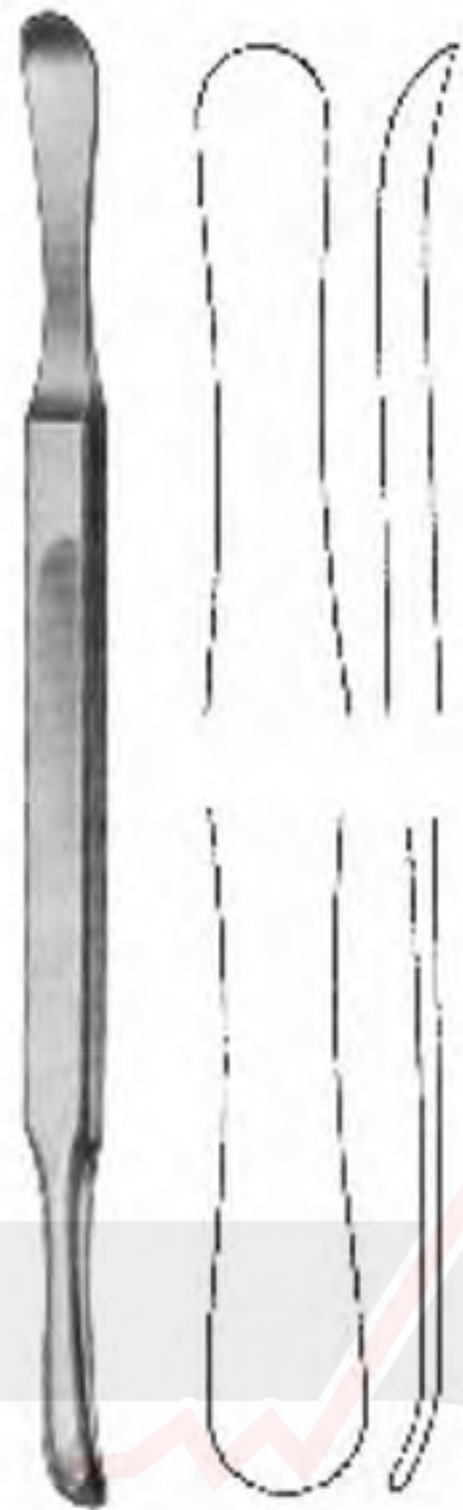

**RP575**  
**Scladin**  
19.5 cm



**RP576**  
**Chompret**  
15 cm



**RP577**



**RP578**



**RP579**



**RP580**



**RP581**  
**Freer**  
16 cm



**RP582**  
**Freer**  
16 cm



**RP583**  
**Partsch,mod**  
14.5 cm



**RP584**  
**Mead**  
16.5 cm



**RP585**  
**Mead**  
18 cm

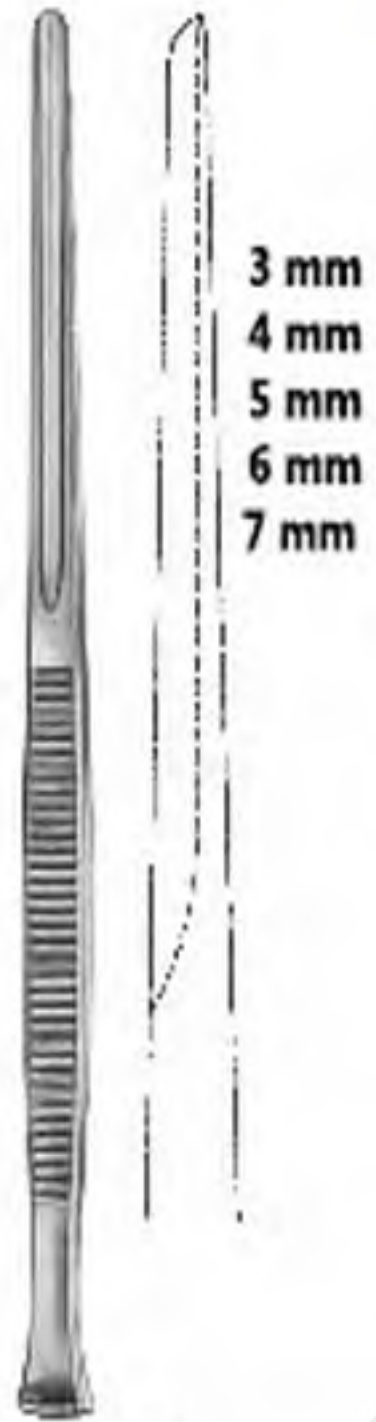

**RP586**  
Partsch  
17 cm



**RP587**  
Freer  
16 cm



**RP588**  
Freer  
16 cm



**RP589**  
Lucas  
16 cm



**RP590**  
Lucas  
16 cm



**RP591**  
Lambotte  
12.5 cm



**RP592**  
14 cm



**RP593**  
Partsch  
14 cm



**RP594**  
Partsch  
17 cm

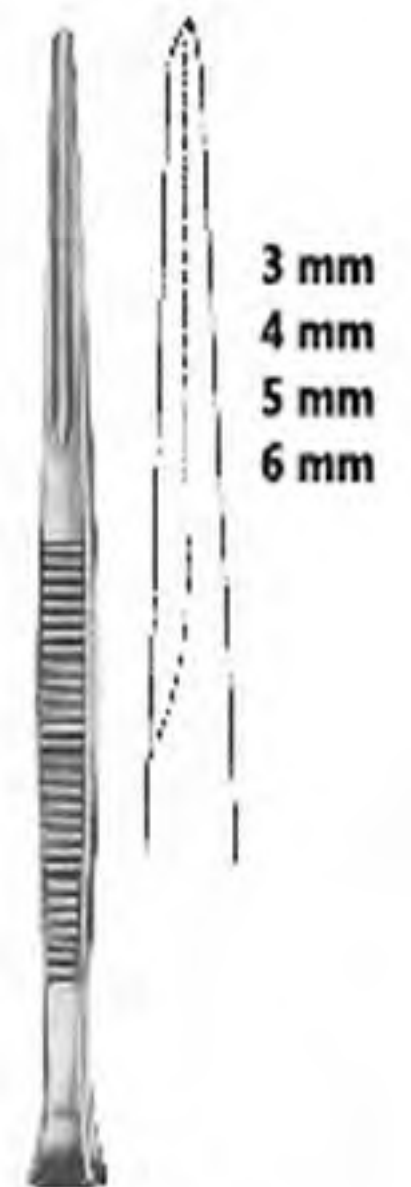

**RP595**  
Partsch  
14 cm

## Clamp Forceps



**RP596**  
Ivory lightweight  
17 cm



**RP597**  
Brewer  
17.5 cm



**RP598**  
Stoke  
17.5 cm



**RP599**  
Ainsworth  
17 cm



**RP600**  
Ivory  
17 cm

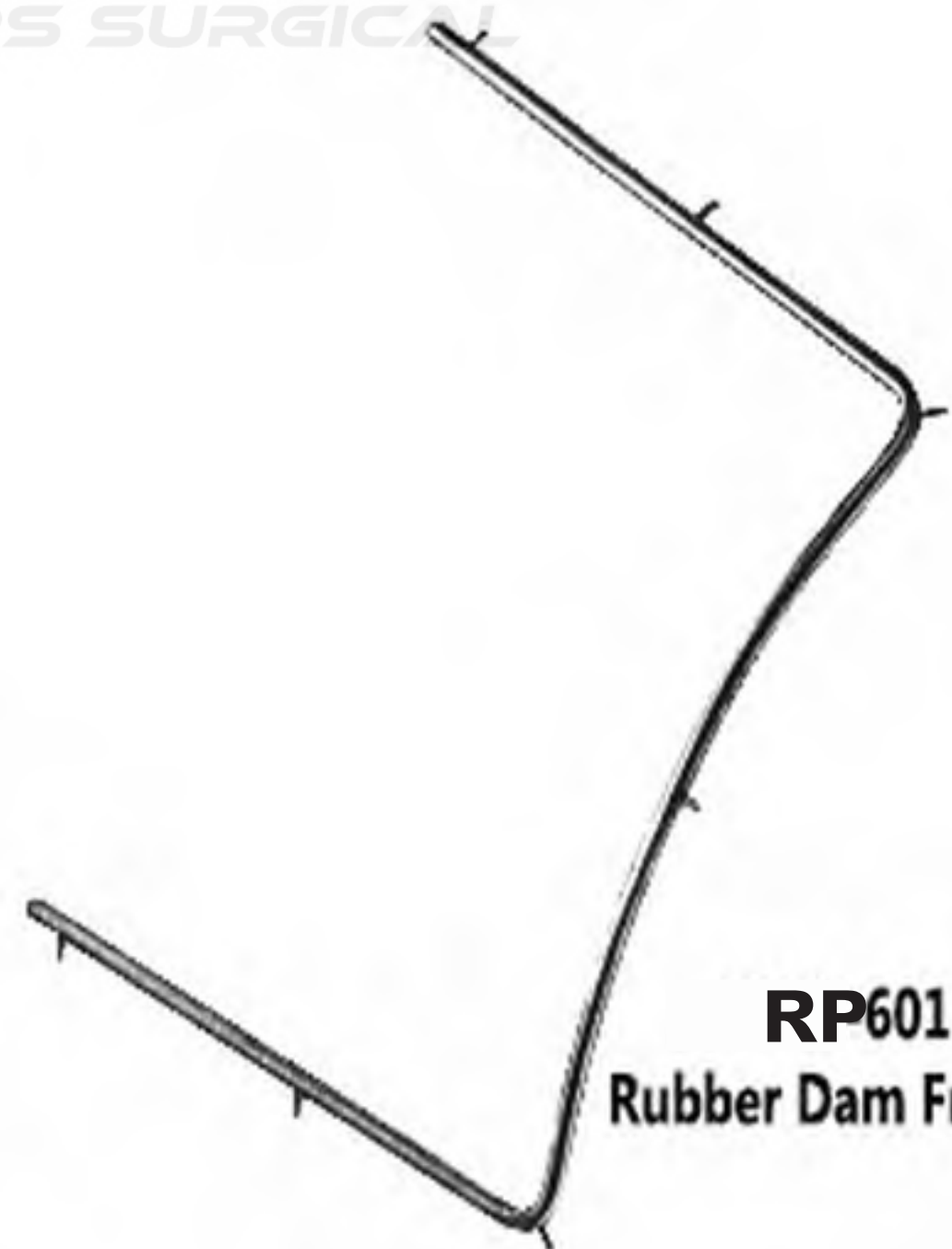

**RP601**  
Rubber Dam Frame

**RP-602**  
Fig-1  
Adson  
12 cm



**RP-603**  
Fig-1  
Adson 1\*2  
12 cm



**RP-604**  
Fig-1  
Semken-Taylor  
12.5 cm



**RP-605**  
Fig-2  
Semken-Taylor  
12.5 cm



**RP-606**  
Fig-1  
Semken-Taylor 1\*2  
12.5 cm



**RP-607**  
Fig-2  
Semken-Taylor 1\*2  
12.5 cm



**RP-608**  
12 cm



**RP-609**  
11.5 cm



**RP-610**  
11.5 cm



**RP-611**  
11.5 cm



# COTTON & DRESSING PLIERS

- RP612**  
15 cm

**Suture Plier**

- RP613**  
Fig-1  
15 cm

**Goldman Fox  
(Crane Kaplane)**

- RP614**  
Fig-2  
15 cm

**Goldman Fox  
(Crane Kaplane)**

- RP615**  
Fig-1  
15 cm

**Self Locking**

- RP616**  
Fig-2  
15 cm

**Self Locking**

- RP617**  
Fig-1  
15 cm

**Flagg**

- RP618**  
Fig-2  
15 cm

**London College**

- RP619**  
Fig-3  
16 cm

**Mariam**

- RP620**  
Fig-4  
13 cm

**Perry**

- RP621**  
Fig-18L  
16 cm

**Self Locking**

- RP622**  
Fig-2  
16 cm

**College**

- RP623**  
Fig-3  
16 cm

**College**



# MOUTH MIRRORS

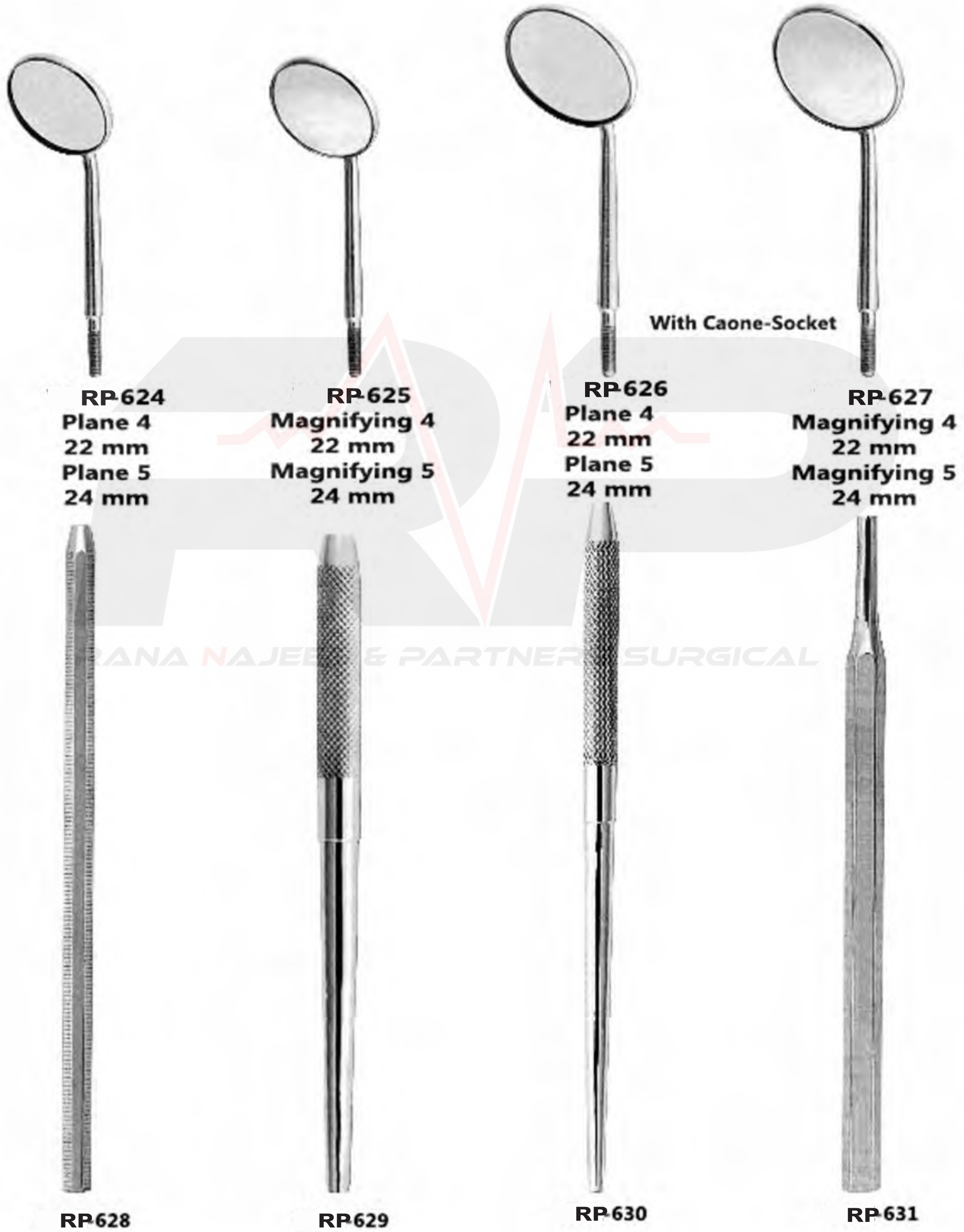

**RP-624**  
Plane 4  
22 mm  
Plane 5  
24 mm

**RP-625**  
Magnifying 4  
22 mm  
Magnifying 5  
24 mm

**RP-626**  
Plane 4  
22 mm  
Plane 5  
24 mm

**RP-627**  
Magnifying 4  
22 mm  
Magnifying 5  
24 mm

**RP-628**

**RP-629**

**RP-630**

**RP-631**





**RP-632**  
**Fig-3L**



**RP-633**  
**Fig-7**



**RP-634**  
**Fig-5L**



**RP-635**  
**Fig-5A**



**RP-636**  
**Fig-3**



**RP-637**  
**Fig-3G**



**RP-638**  
**Fig-4**



**RPA**  
Single ended  
Knurling round



**RPB**  
Double ended  
Knurling round



**RPC**  
Single ended  
Octangle Serrated



**RPD**  
Double ended  
Octangle Serrated



**RPE**  
Single ended  
Hollow round



**RPF**  
Double ended  
Hollow round



**RPG**  
Double ended  
Hollow round  
Grooved



**RPH**  
Double ended  
Swiss Pattern  
Octangle

**Note:**

If you have preference different from the standard handle shown,  
please specify the optimal handle number when ordering.

If the tip/handle combination you desire is not shown,  
we will be glade to provideyou with a qoute for its preparation.



**RP-639**  
**Fig-23**

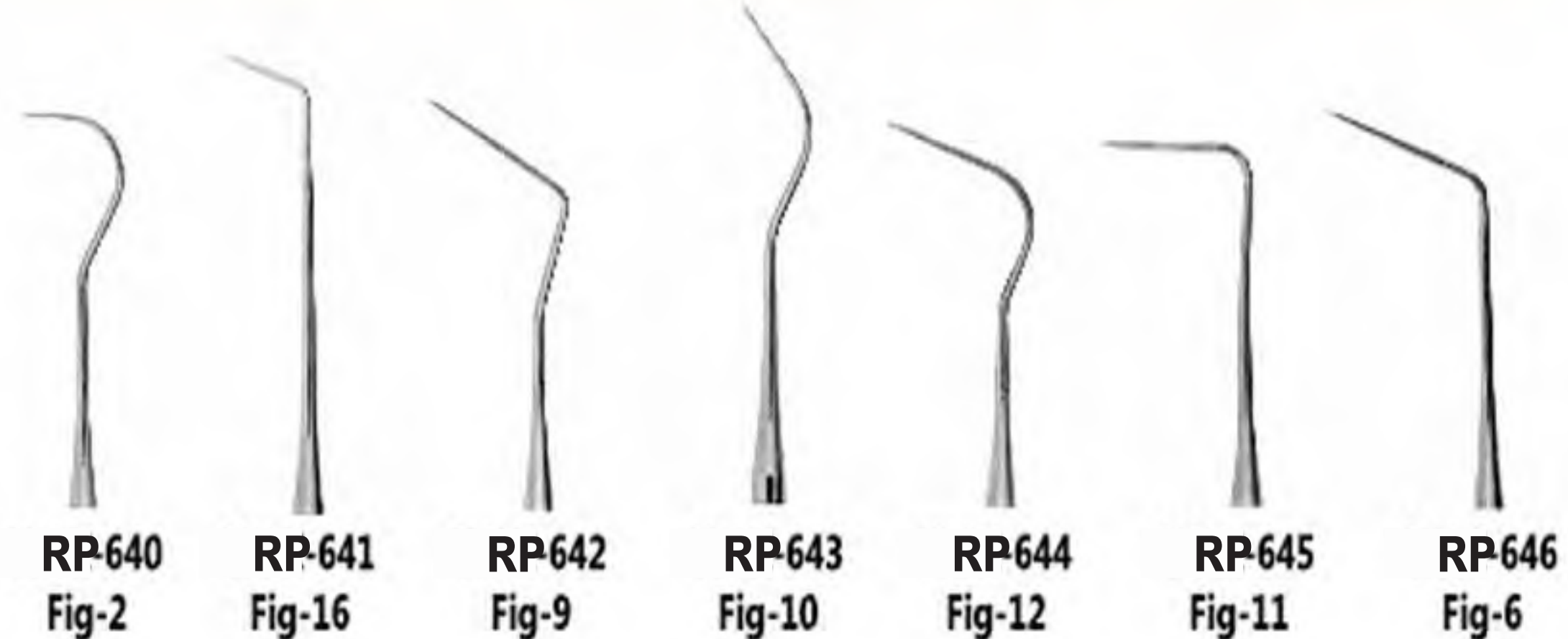

**RP-640 Fig-2**    **RP-641 Fig-16**    **RP-642 Fig-9**    **RP-643 Fig-10**    **RP-644 Fig-12**    **RP-645 Fig-11**    **RP-646 Fig-6**

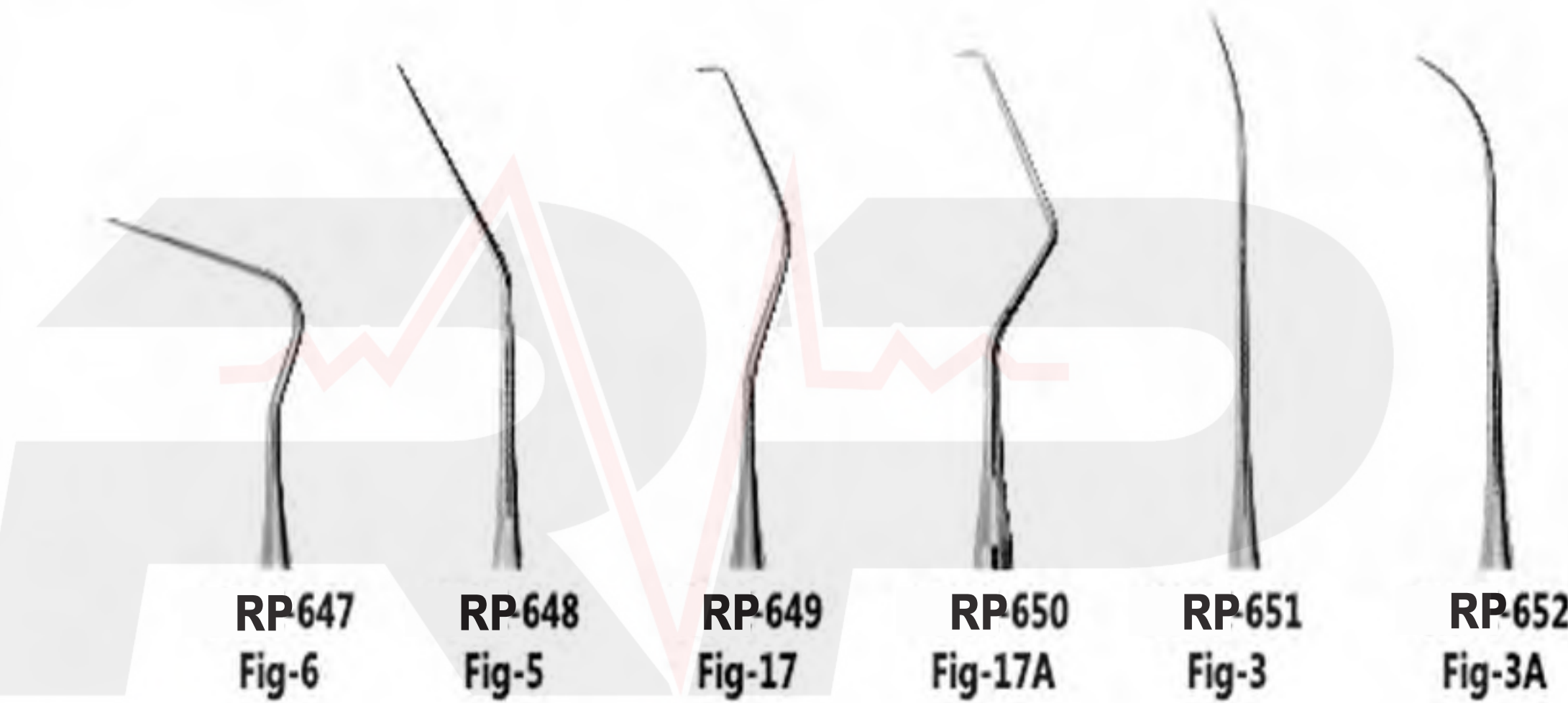

**RP-647 Fig-6**    **RP-648 Fig-5**    **RP-649 Fig-17**    **RP-650 Fig-17A**    **RP-651 Fig-3**    **RP-652 Fig-3A**

RANA NAJEEB & PARTNERS SURGICAL

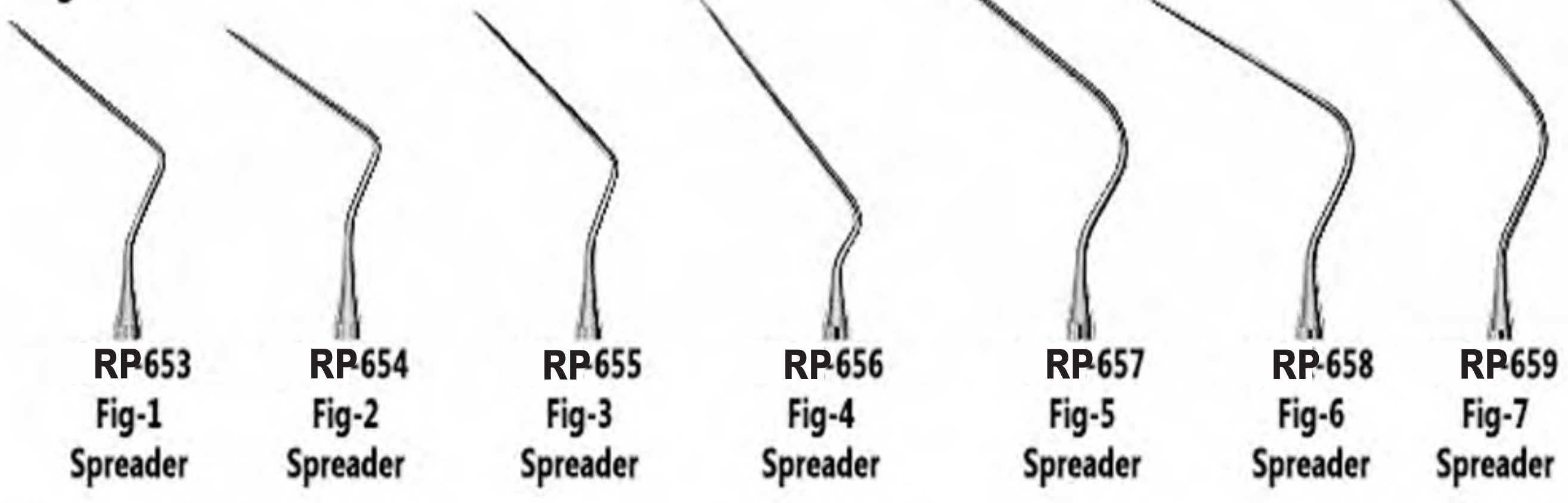

**RP-653 Fig-1 Spreader**    **RP-654 Fig-2 Spreader**    **RP-655 Fig-3 Spreader**    **RP-656 Fig-4 Spreader**    **RP-657 Fig-5 Spreader**    **RP-658 Fig-6 Spreader**    **RP-659 Fig-7 Spreader**

## Endodontic Instruments



**RP-660 Williams**

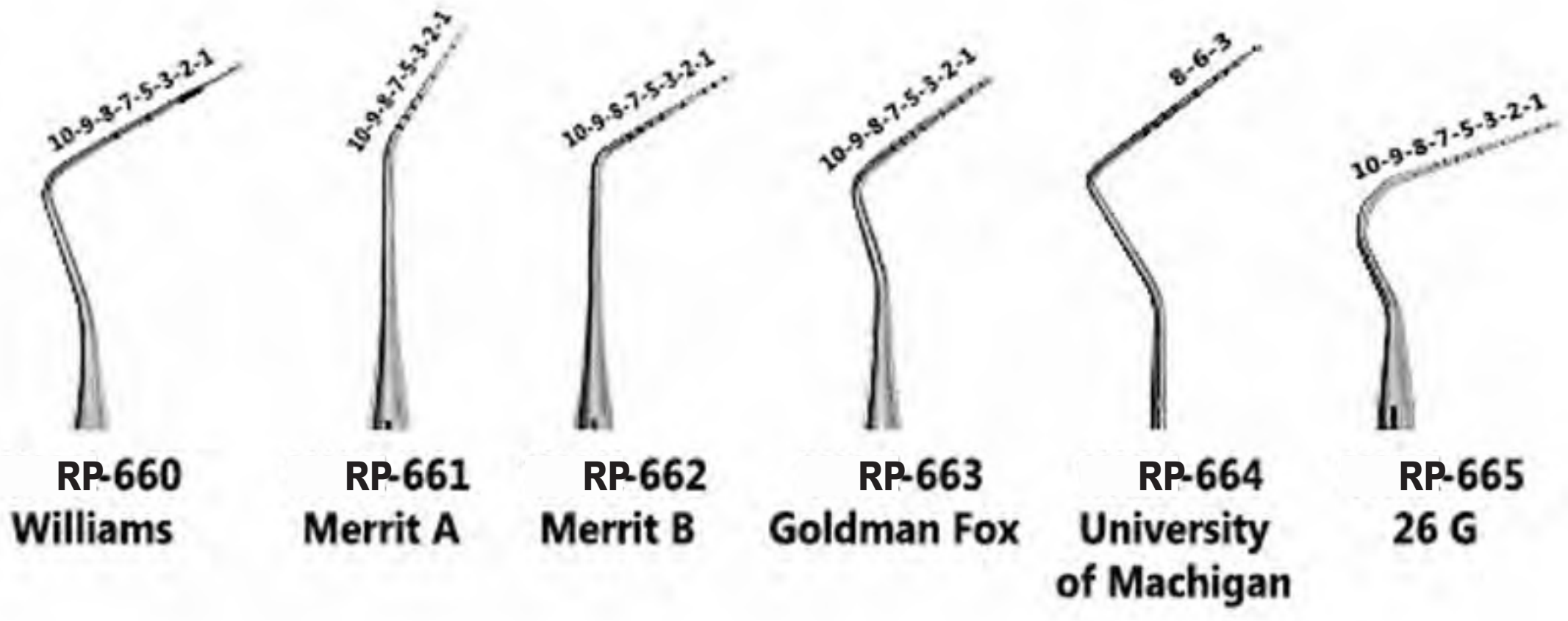

**RP-660 Williams**      **RP-661 Merrit A**      **RP-662 Merrit B**      **RP-663 Goldman Fox**      **RP-664 University of Michigan**      **RP-665 26 G**

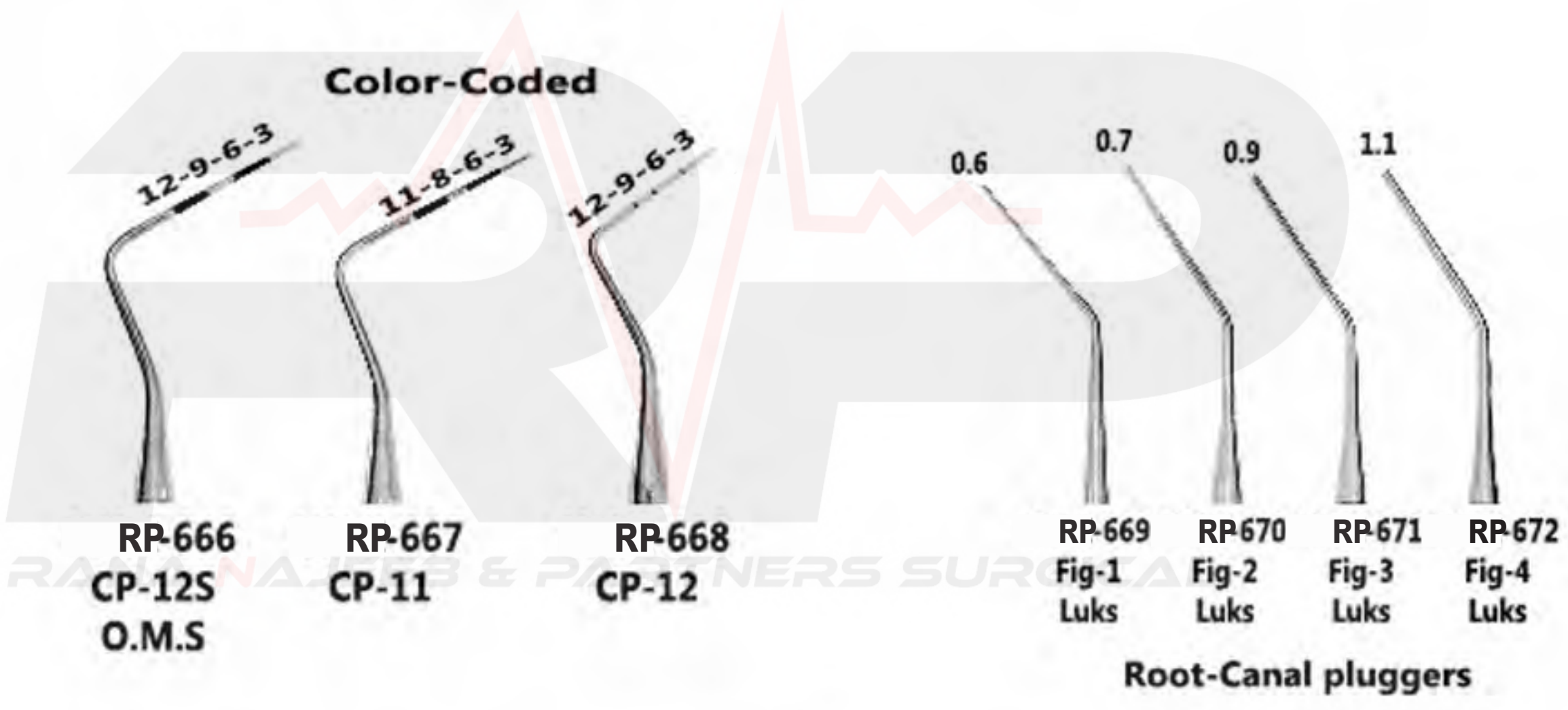

**RP-666 CP-12S O.M.S**      **RP-667 CP-11**      **RP-668 CP-12**      **RP-669 Fig-1 Luks**      **RP-670 Fig-2 Luks**      **RP-671 Fig-3 Luks**      **RP-672 Fig-4 Luks**

**Root-Canal pluggers**

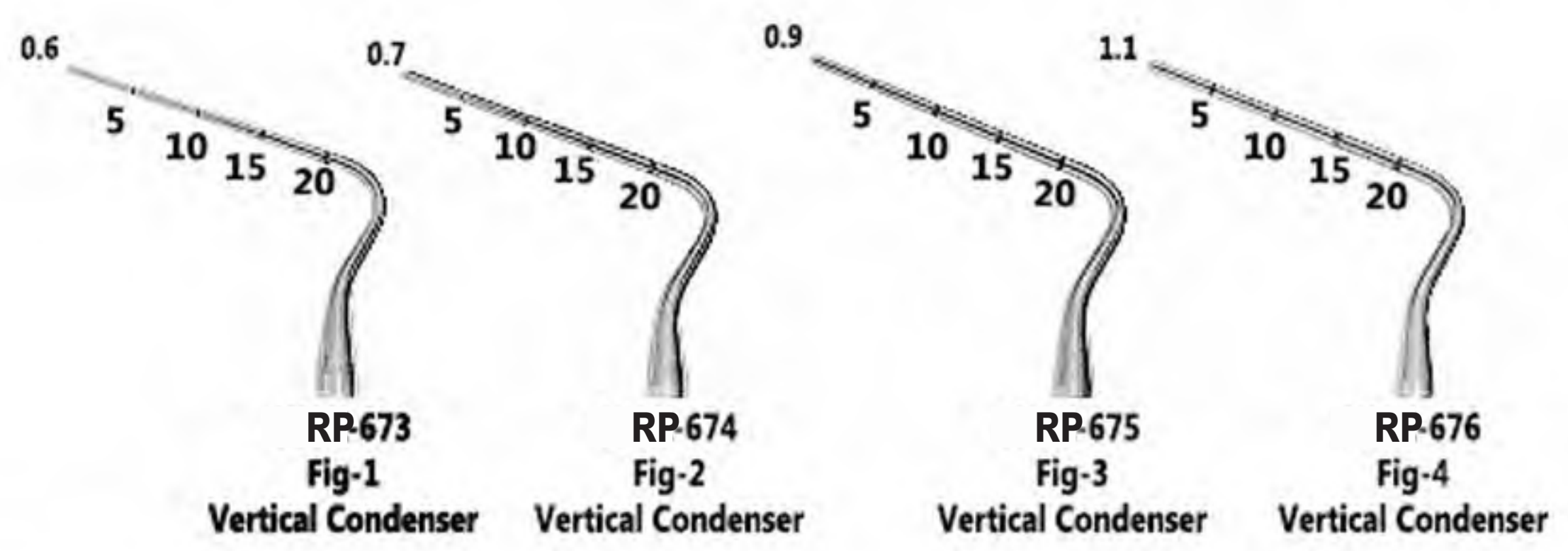

**RP-673 Fig-1 Vertical Condenser**      **RP-674 Fig-2 Vertical Condenser**      **RP-675 Fig-3 Vertical Condenser**      **RP-676 Fig-4 Vertical Condenser**

**Probes**

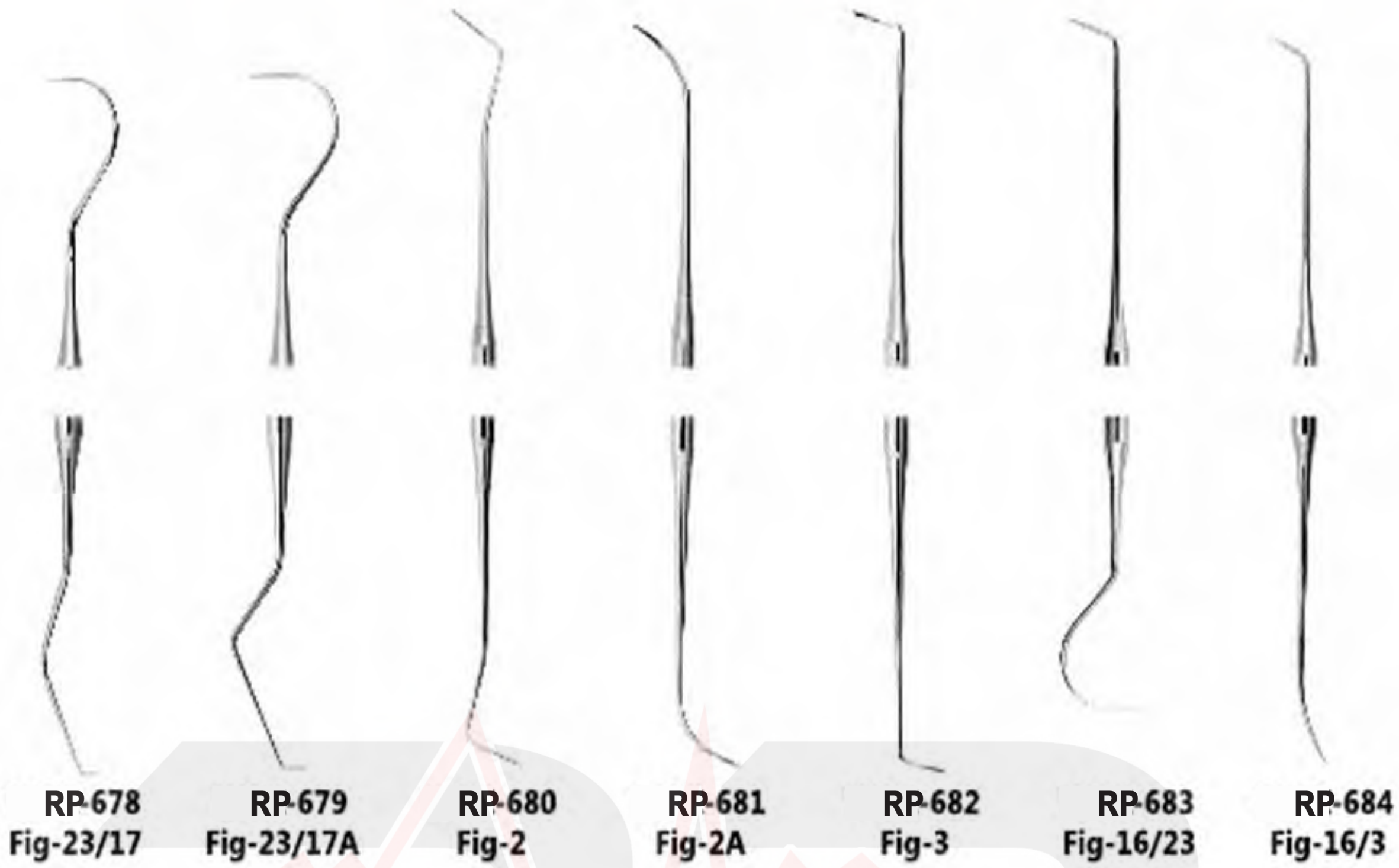

RP-678 Fig-23/17    RP-679 Fig-23/17A    RP-680 Fig-2    RP-681 Fig-2A    RP-682 Fig-3    RP-683 Fig-16/23    RP-684 Fig-16/3

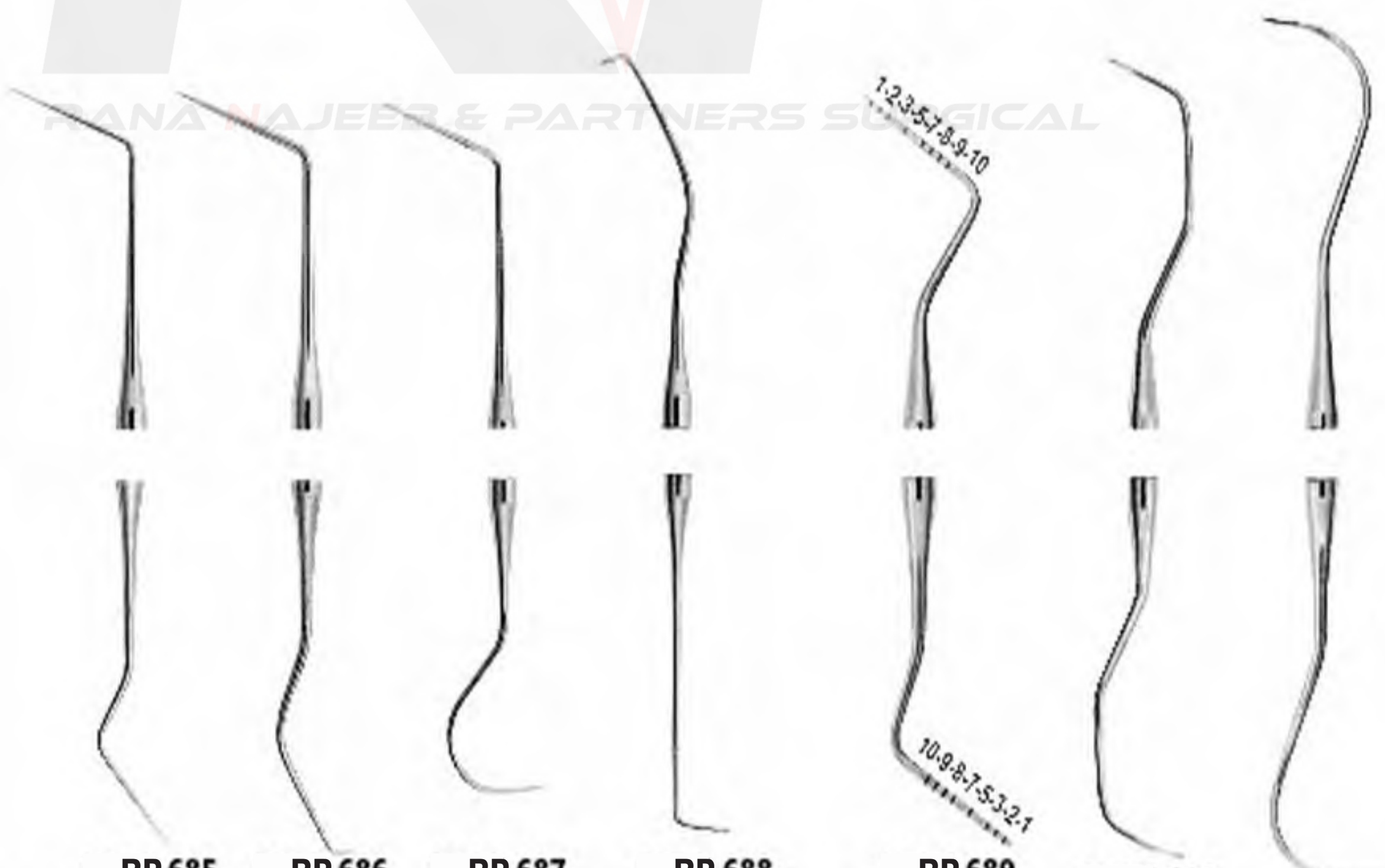

RP677 Fig-UT 1/2 Cctoni  
 RP-685 Fig-6/1    RP-686 Fig-6/17    RP-687 Fig-6/23    RP-688 Fig-UT 1/2 Cottoni    RP-689 Goldman Fox Williams    RP-690 Fig-1 N Nabers    RP-691 Fig-2 N Nabers

**Root Canal Explorers**

**Endodontic Instruments**

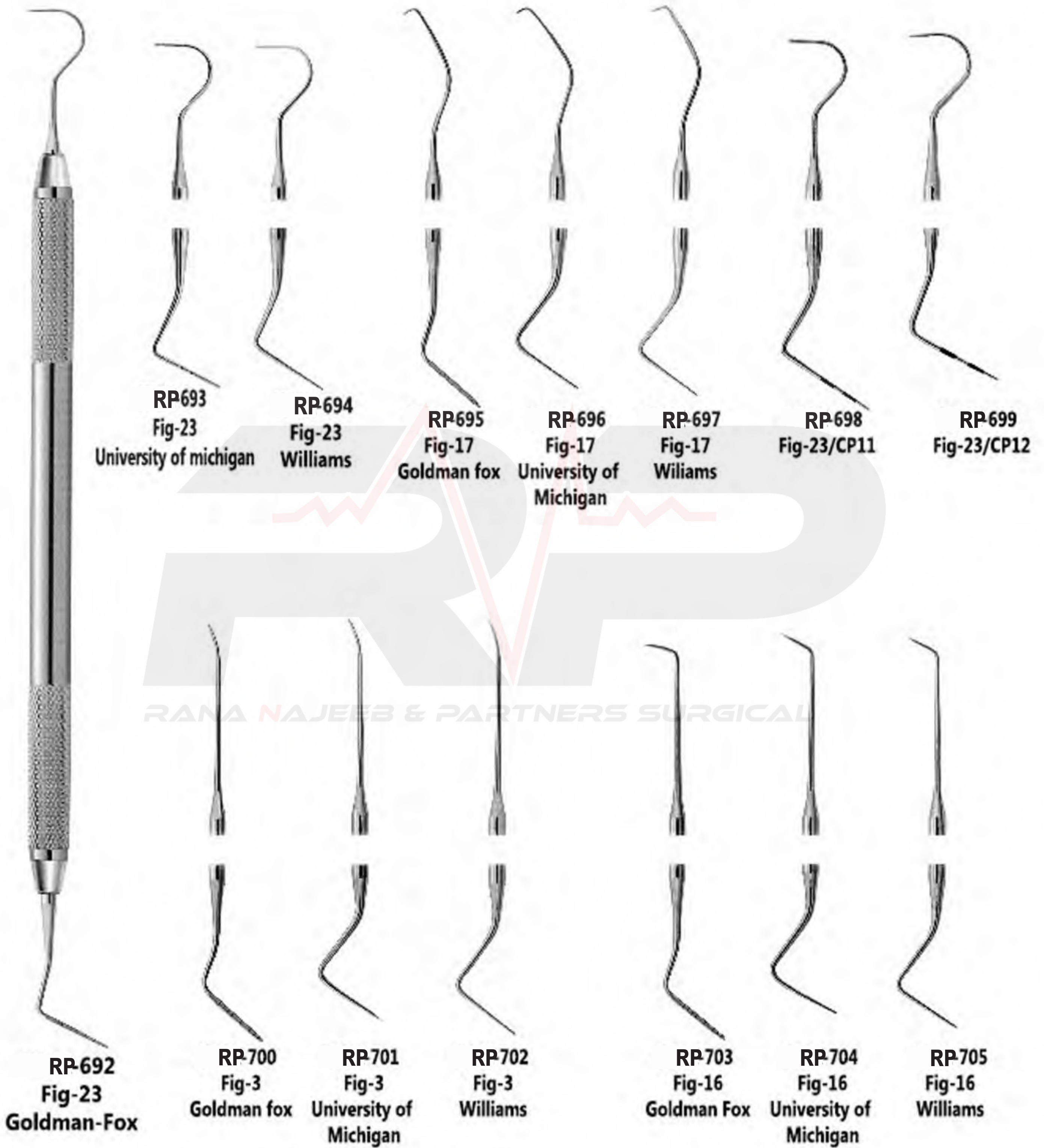

**Amalgam Instruments**



**RP-706  
Fig-1**

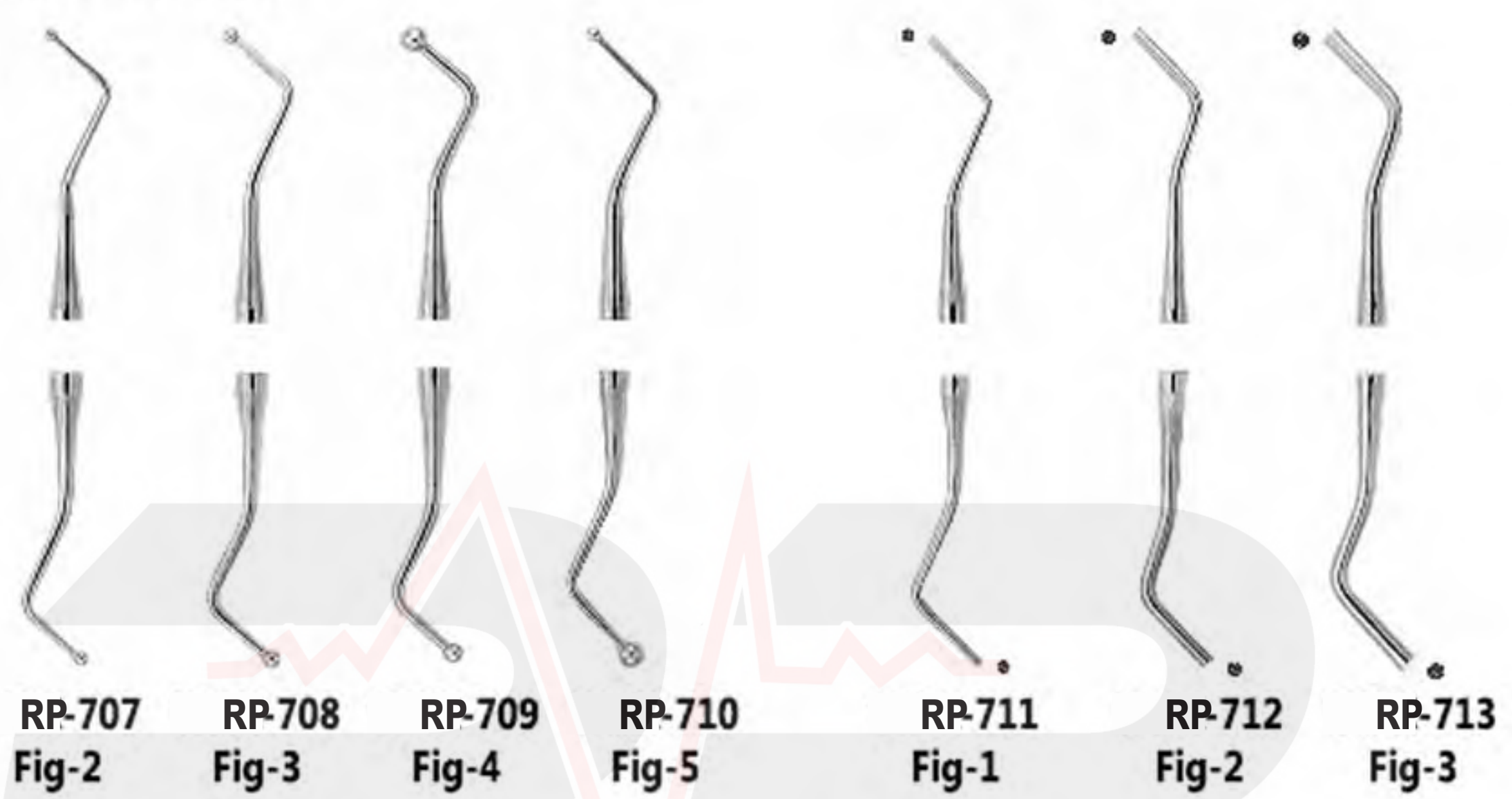

**RP-707 Fig-2    RP-708 Fig-3    RP-709 Fig-4    RP-710 Fig-5    RP-711 Fig-1    RP-712 Fig-2    RP-713 Fig-3**

RANA NAJEEB & PARTNERS SURGICAL

**Smooth**

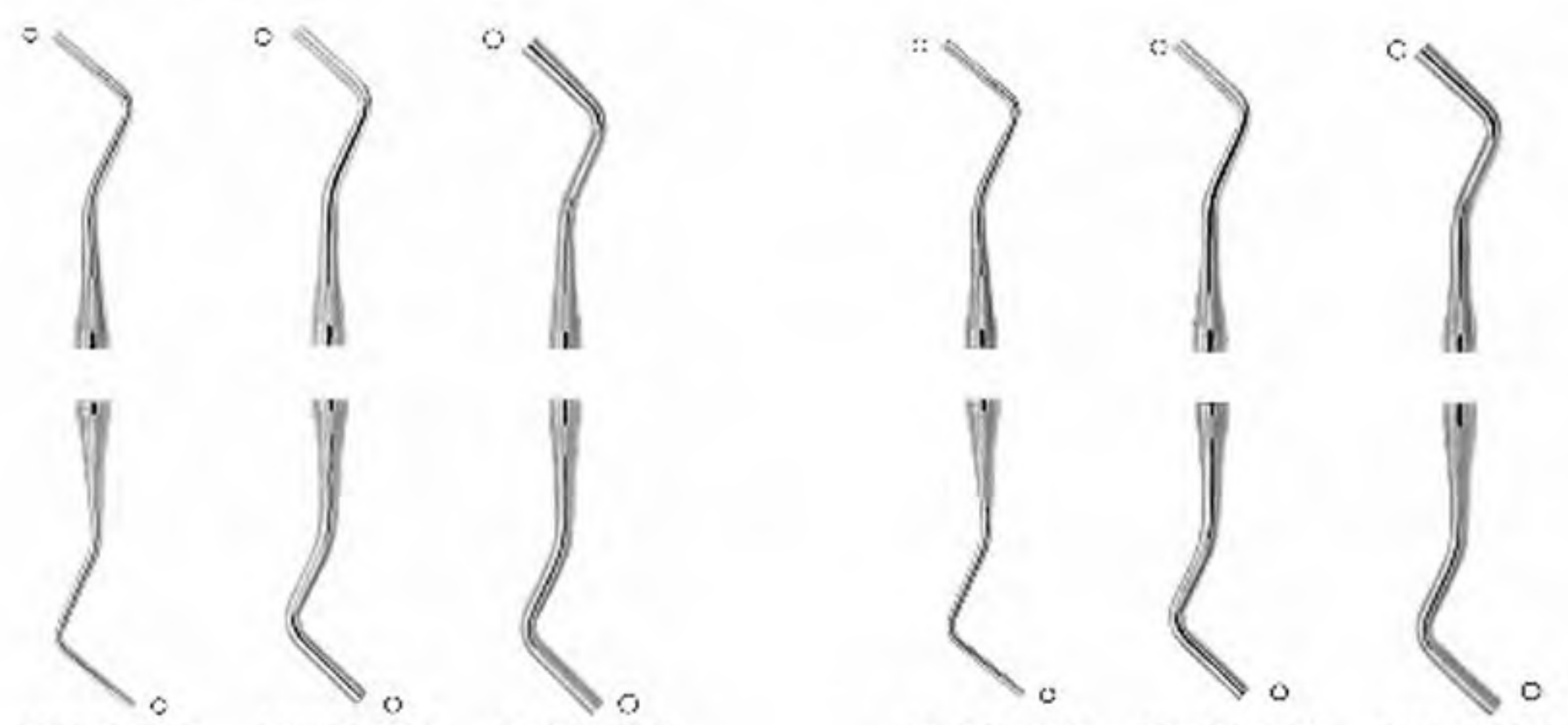

**RP-714 Fig-1L    RP-715 Fig-2L    RP-716 Fig-3L    RP-717 Fig-1    RP-718 Fig-2    RP-719 Fig-3**

## Amalgam Instruments

**Serrated**

**Smooth**



**RP-720  
Fig-1**



**RP-720 Fig-1    RP-721 Fig-2    RP-722 Fig-3    RP-723 Fig-4    RP-724 Fig-1L    RP-725 Fig-2L    RP-726 Fig-3L    RP-727 Fig-4L**

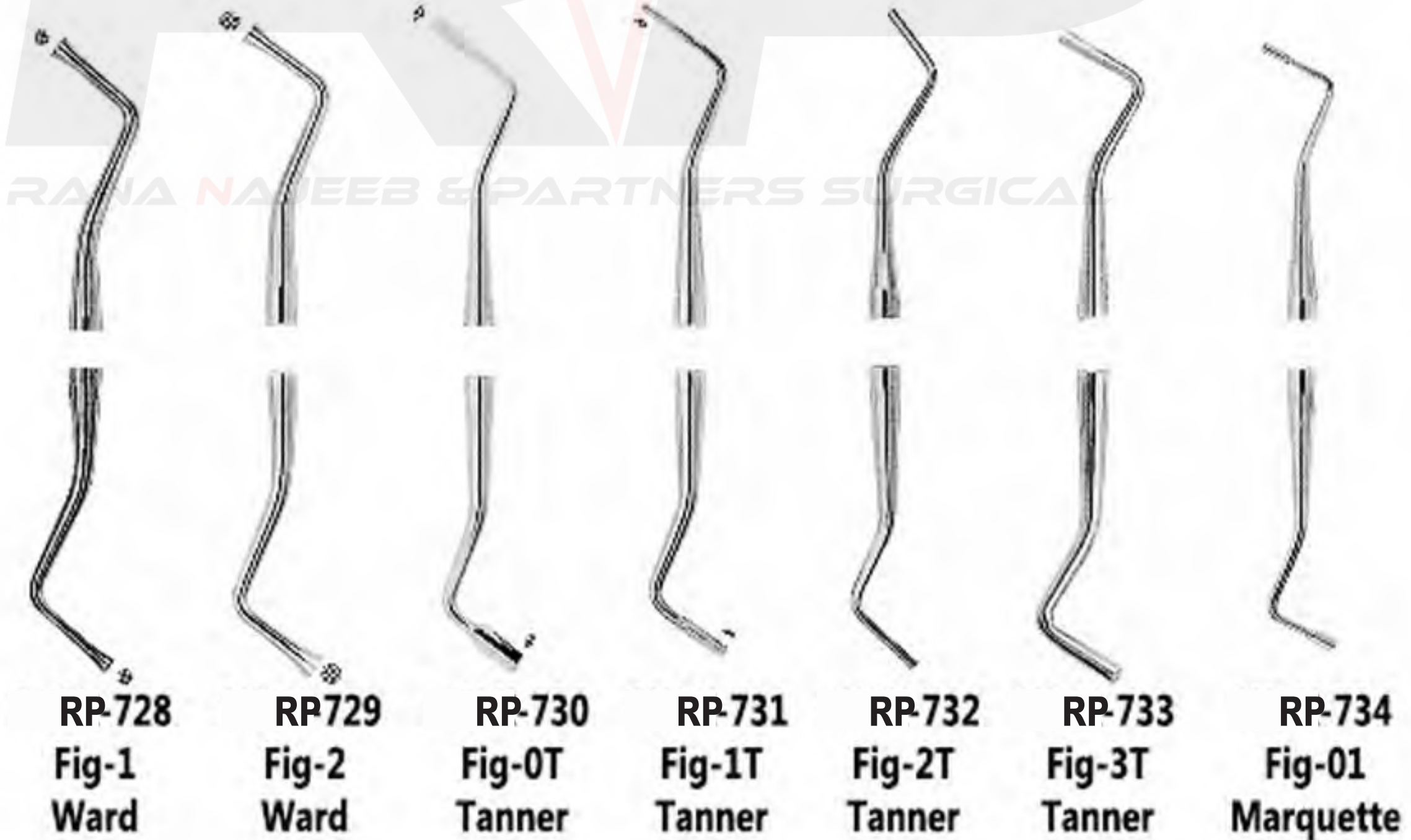

**RP-728 Fig-1 Ward    RP-729 Fig-2 Ward    RP-730 Fig-0T Tanner    RP-731 Fig-1T Tanner    RP-732 Fig-2T Tanner    RP-733 Fig-3T Tanner    RP-734 Fig-01 Marquette**

**Serrated**



**Amalgam Instruments**

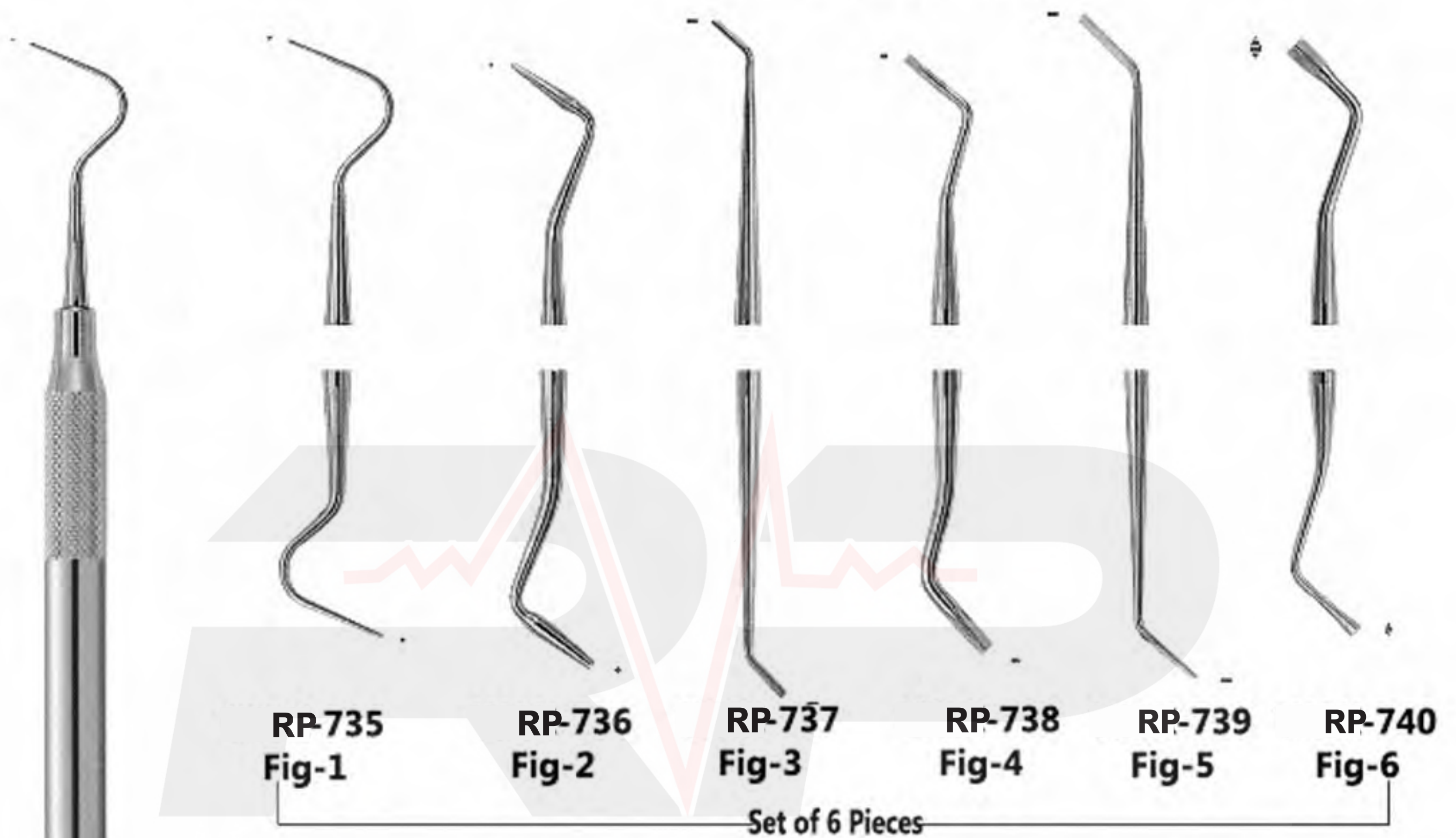

RANA NAJEEB & PARTNERS SURGICAL

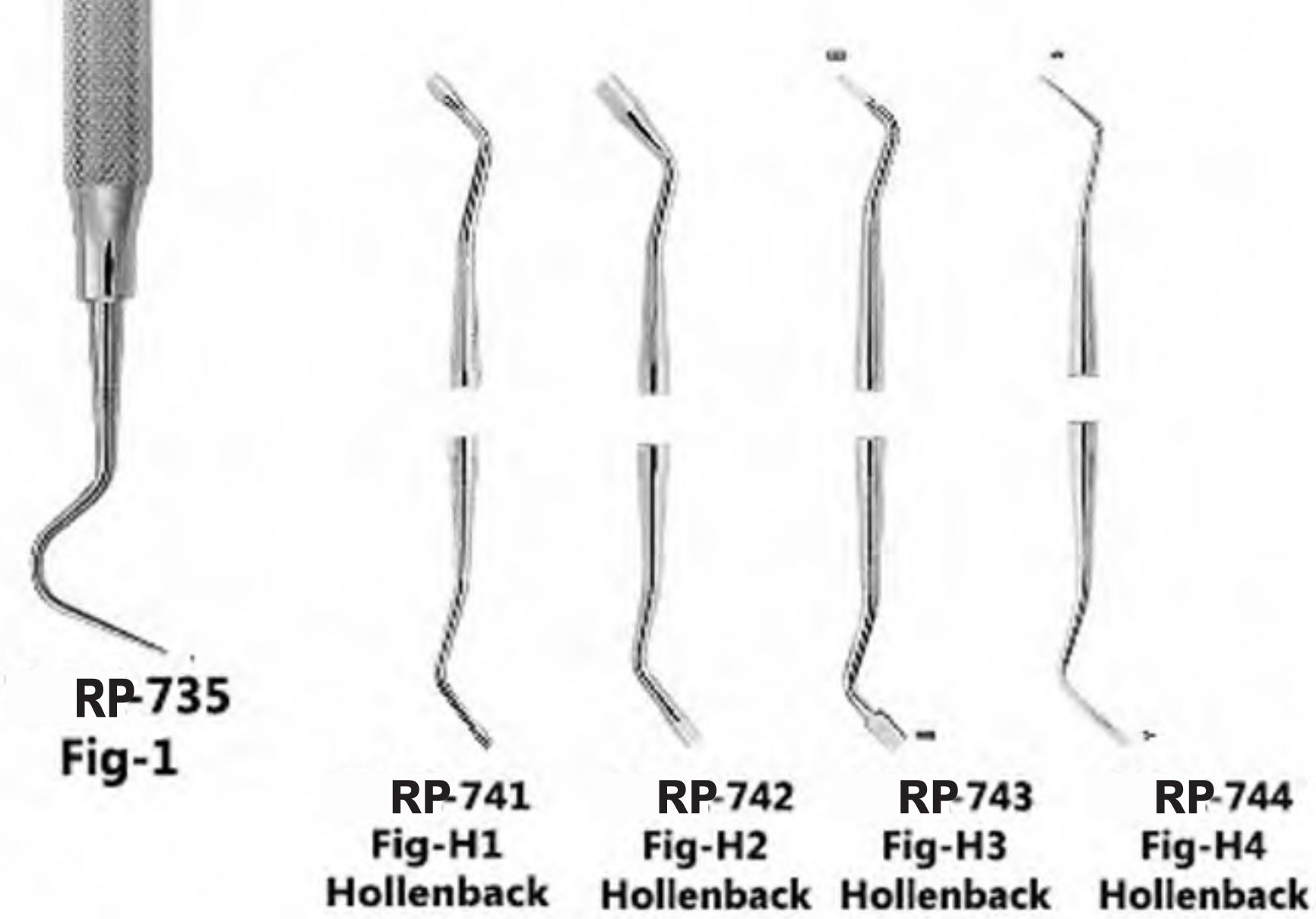

**RP-735 Fig-1**

## Plastic Filling Instruments

### Burnishers

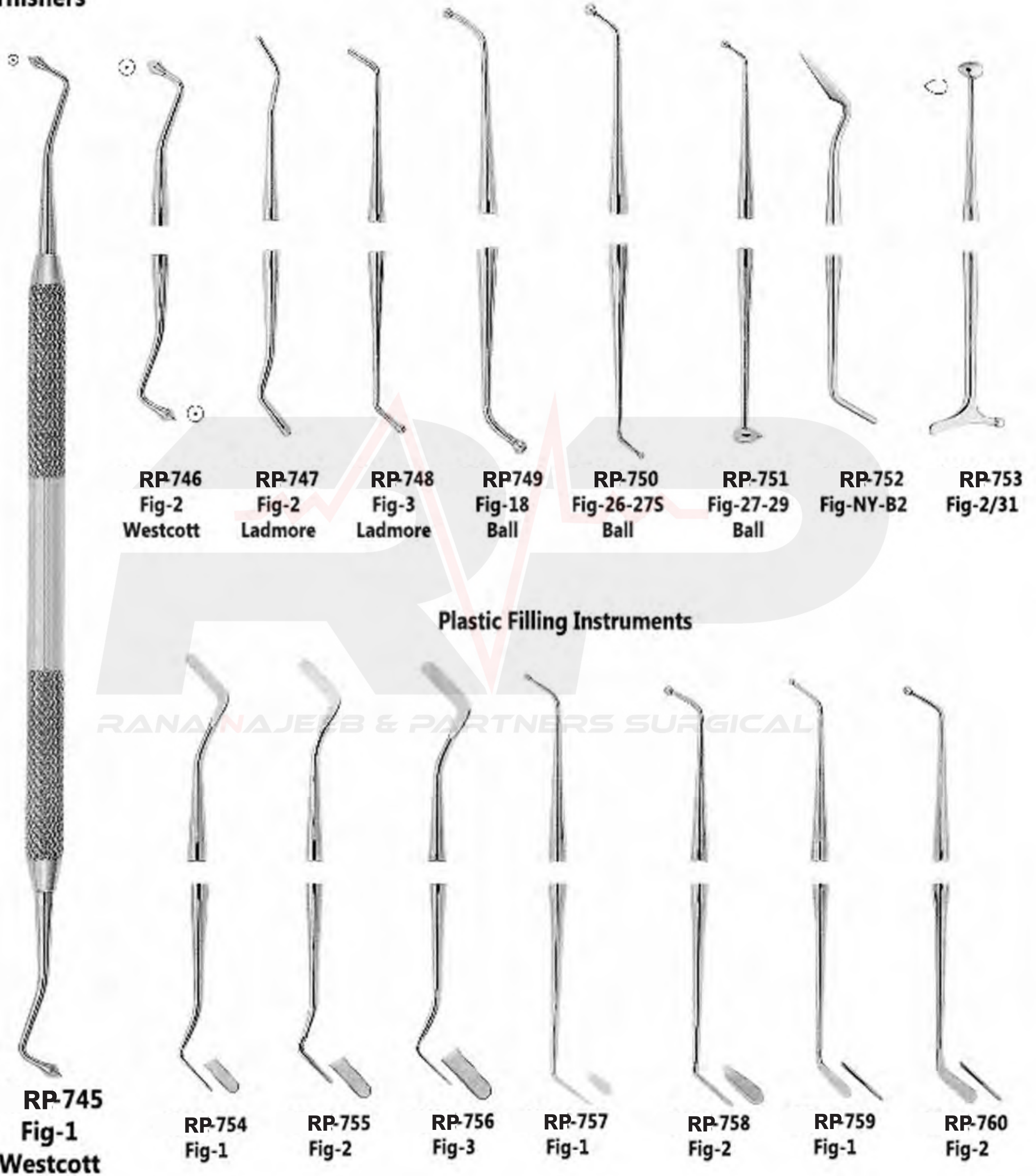

## Amalgam Carvers



**RP-761**  
**Fig-1**

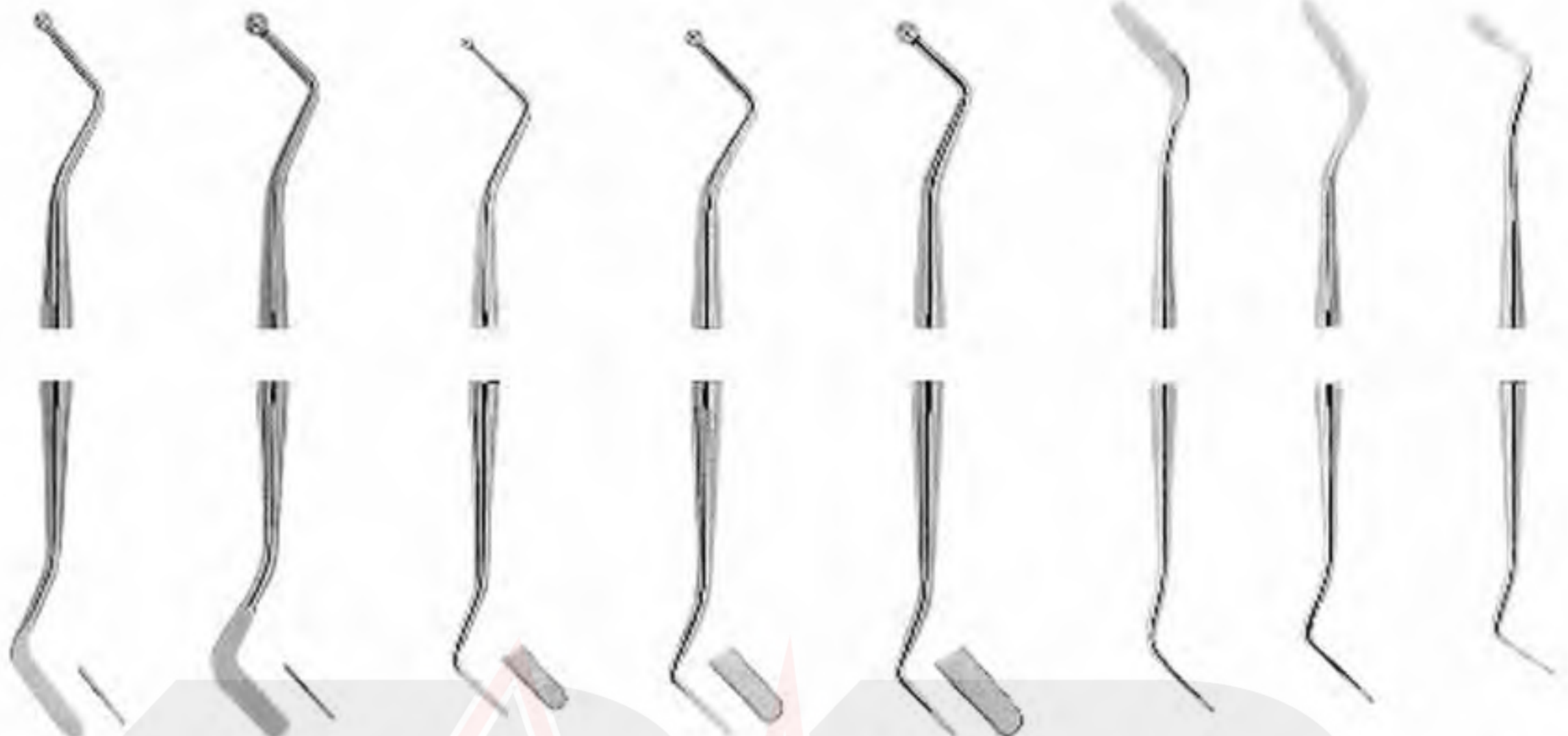

**RP-762 Fig-2**    **RP-763 Fig-3**    **RP-764 Fig-1**    **RP-765 Fig-2**    **RP-766 Fig-3**    **RP-767 Fig-11**    **RP-768 Fig-6**    **RP-769 Fig-179**



**RP-770 Fig-1 Woodson**    **RP-771 Fig-2 Woodson**    **RP-772 Fig-3 Woodson**    **RP-773 Fig-1 Ward**    **RP-774 Fig-1S Ward**    **RP-775 Fig-2 Ward**    **RP-776 Fig-1/2 Hollenbeck**    **RP-777 Fig-3 Hollenbeck**    **RP-778 Fig-3S Hollenbeck**

**Operative Instruments**

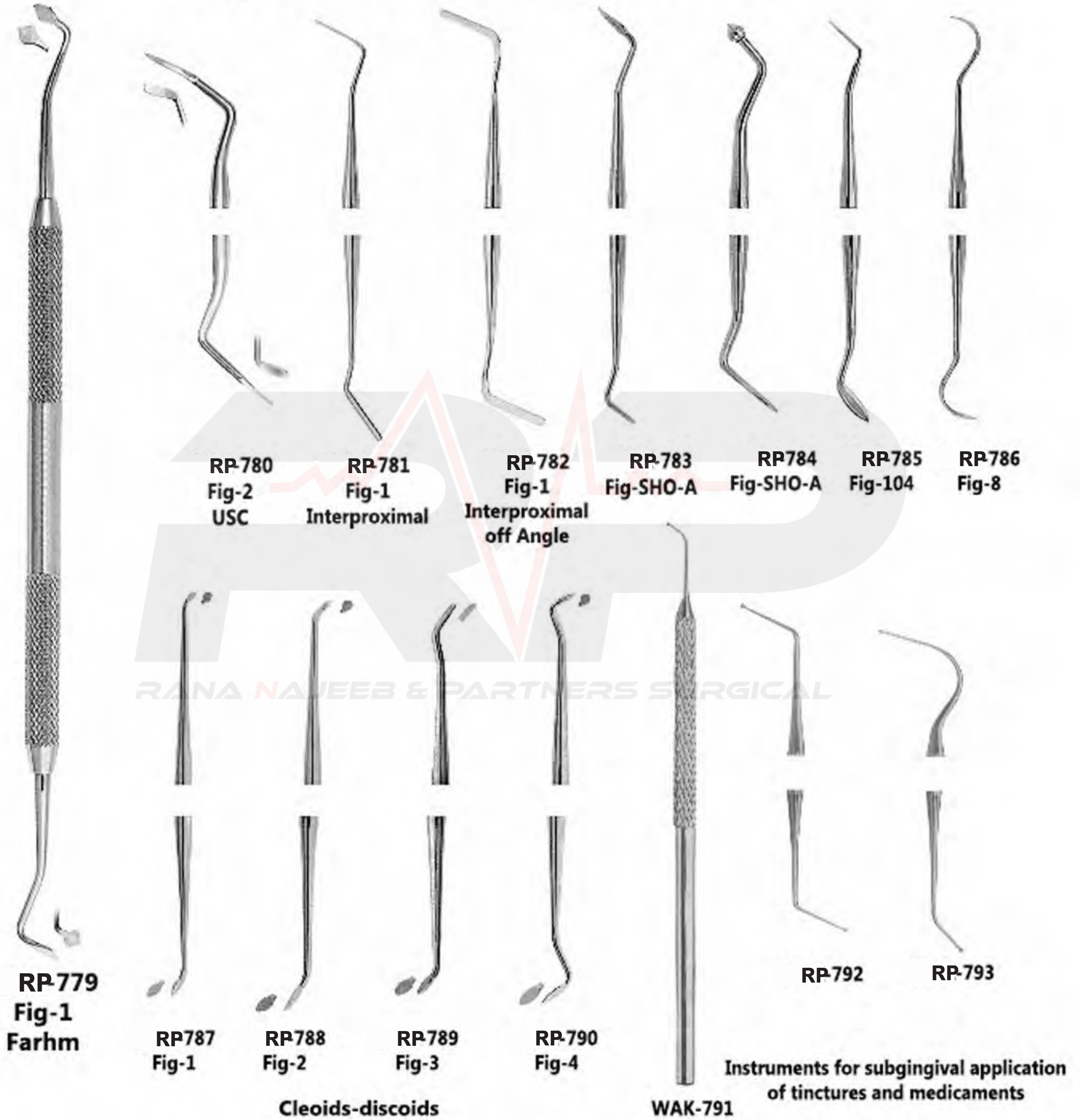

**Gingival margin trimmers**

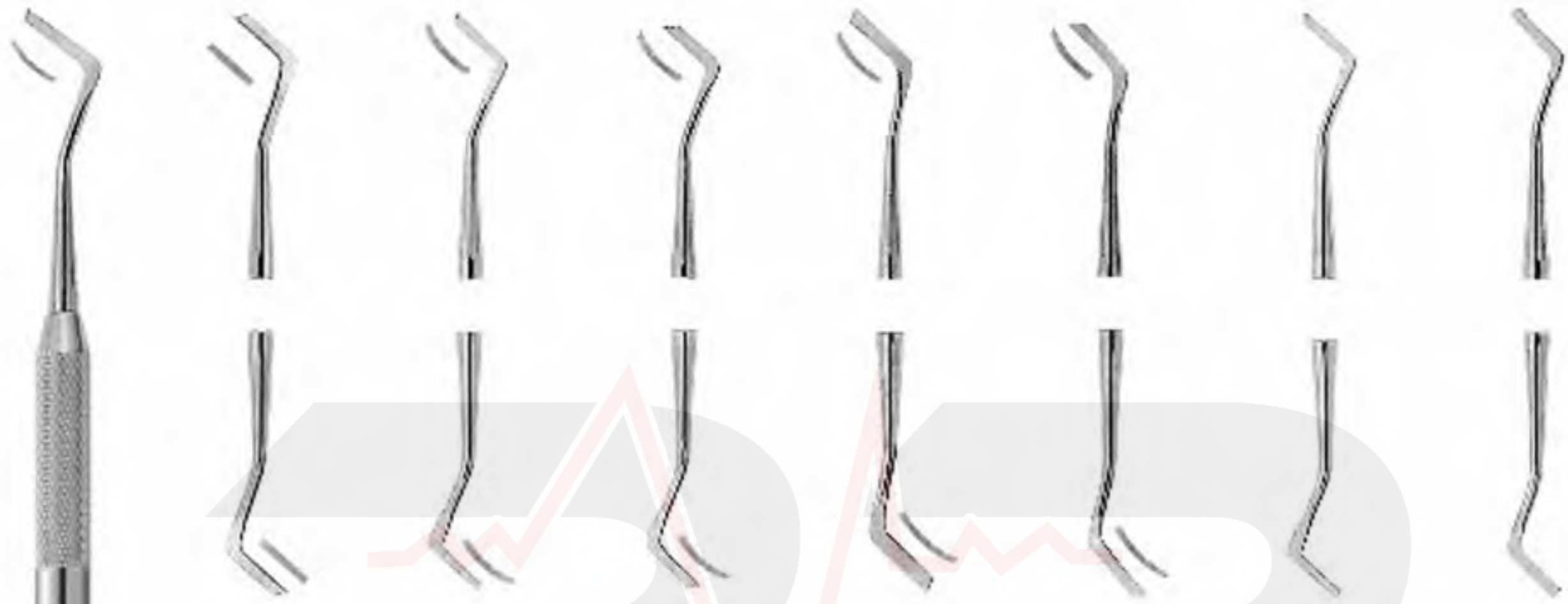

<b>RP-795</b> Fig-2 Black/27	<b>RP-796</b> Fig-3 Black/28	<b>RP-797</b> Fig-4 Black/29	<b>RP-798</b> Fig-1 Black/77-78	<b>RP-799</b> Fig-1 Black/53-54	<b>RP-800</b> Fig-1 Black/53-54	<b>RP-801</b> Fig-2 Black/51-52
------------------------------------	------------------------------------	------------------------------------	---------------------------------------	---------------------------------------	---------------------------------------	---------------------------------------

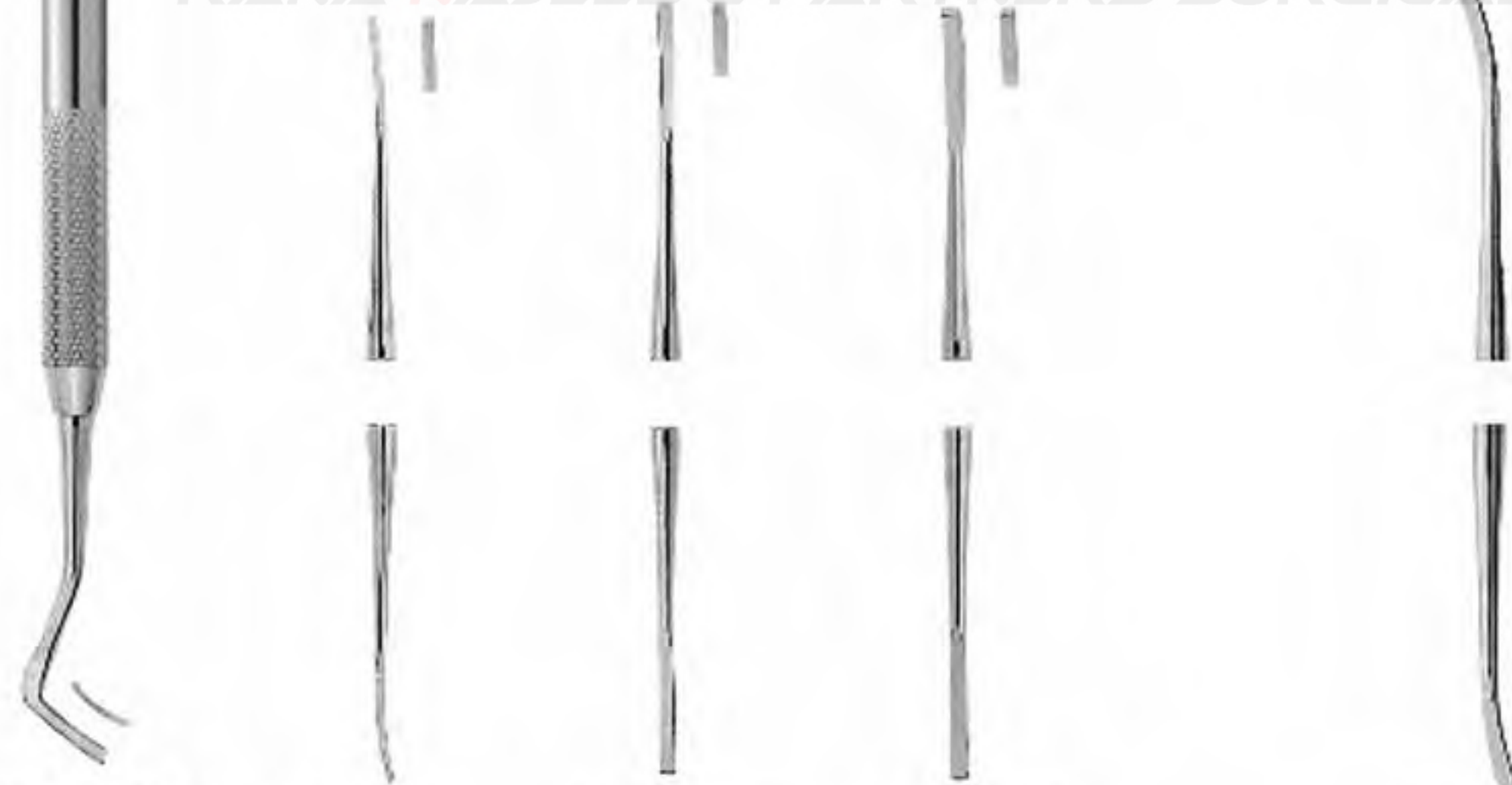

<b>RP-794</b> Fig-1 Black/26	<b>RP-802</b> Fig-1/2 Wedelstaet	<b>RP-803</b> Fig-3/4 Wedelstaet	<b>RP-804</b> Fig-5/6 Wedelstaet	<b>RP-805</b> Fig-1/2 TG Chisel
------------------------------------	--	--	--	---------------------------------------



**RP806**  
**Fig-6**

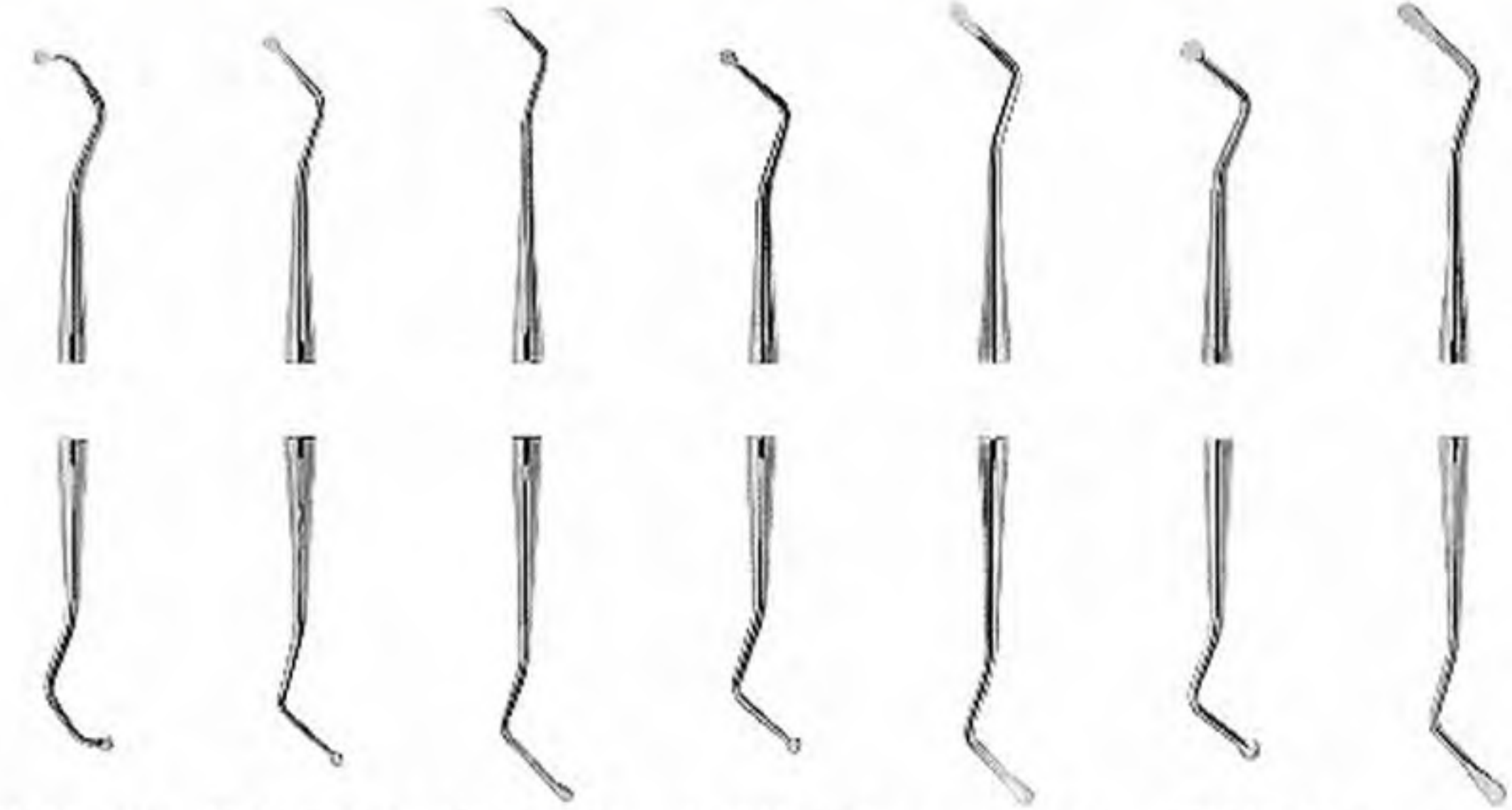

**RP807**  
**Fig-14**

**RP-808**  
**Fig-17**

**RP-809**  
**Fig-17 W**  
**Oval spoon**

**RP-810**  
**Fig-18**

**RP-811**  
**Fig-18 W**  
**Oval spoon**

**RP812**  
**Fig-19**

**RP813**  
**Fig-19 W**  
**Oval spoon**

**025-175S Set of 5**

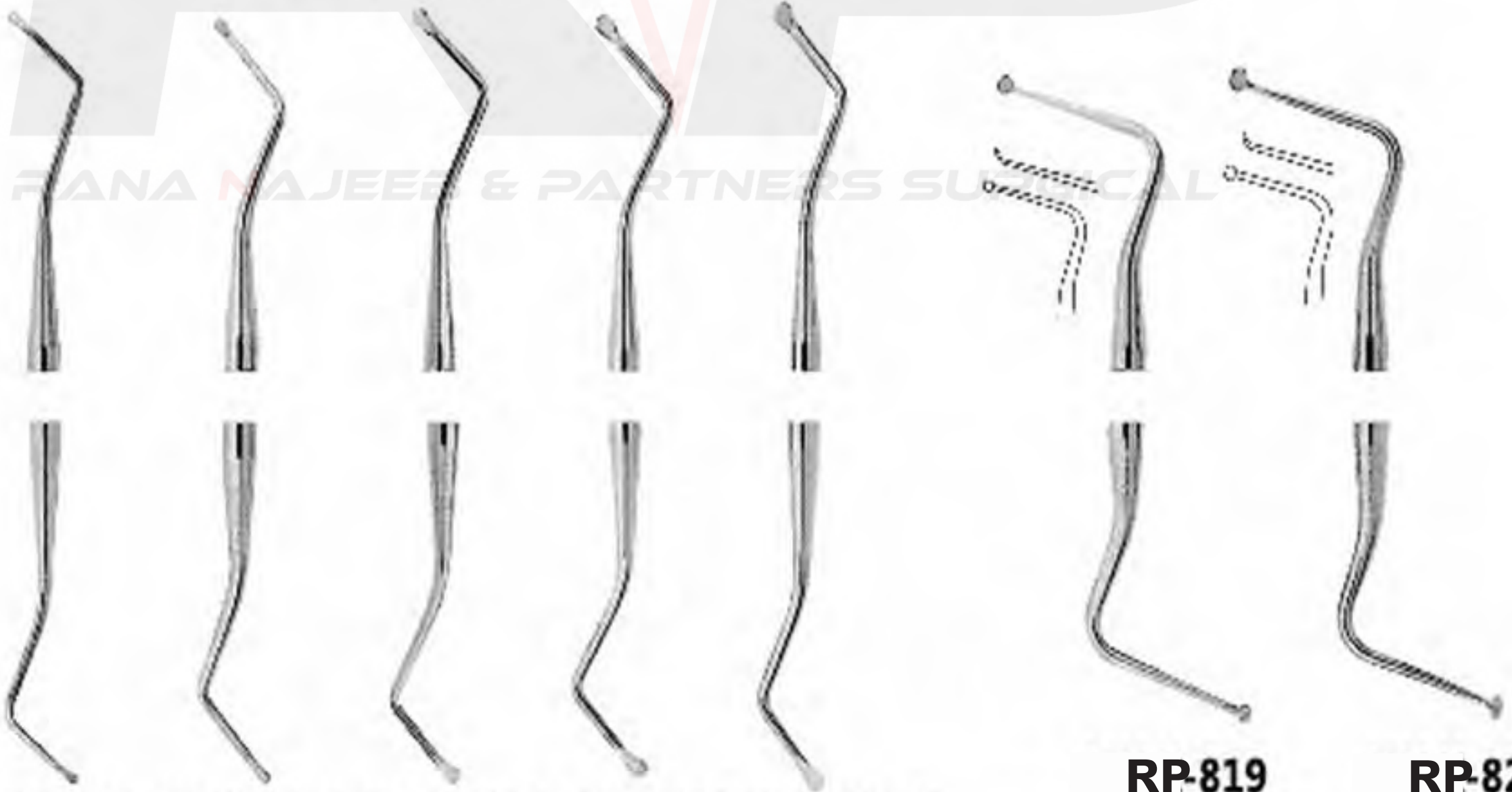

**RP-814**  
**Fig-0**

**RP815**  
**Fig-1**

**RP-816**  
**Fig-2**

**RP-817**  
**Fig-3**

**RP818**  
**Fig-4**

**RP-819**  
**Fig-1**

**RP-820**  
**Fig-2**



**RP-821**  
Fig-38/39

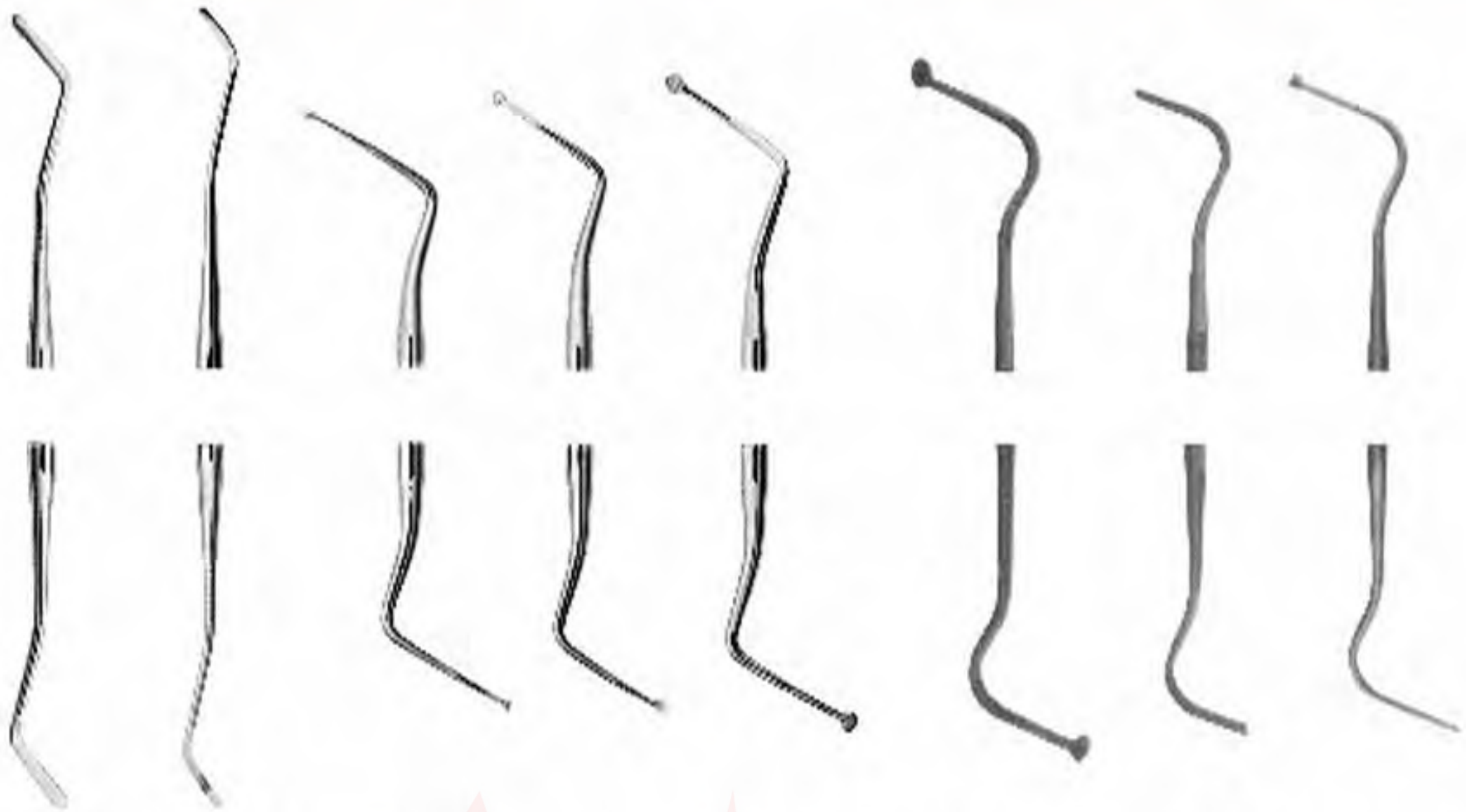

**RP822** Fig-63/64    **RP823** Fig-65/66    **RP-824** Fig-31L    **RP825** Fig-32L    **RP-826** Fig-33L    **RP827** Fig-135/136    **RP-828** Fig-139/140    **RP829** Fig-141/142

**Root Canal Excavators**

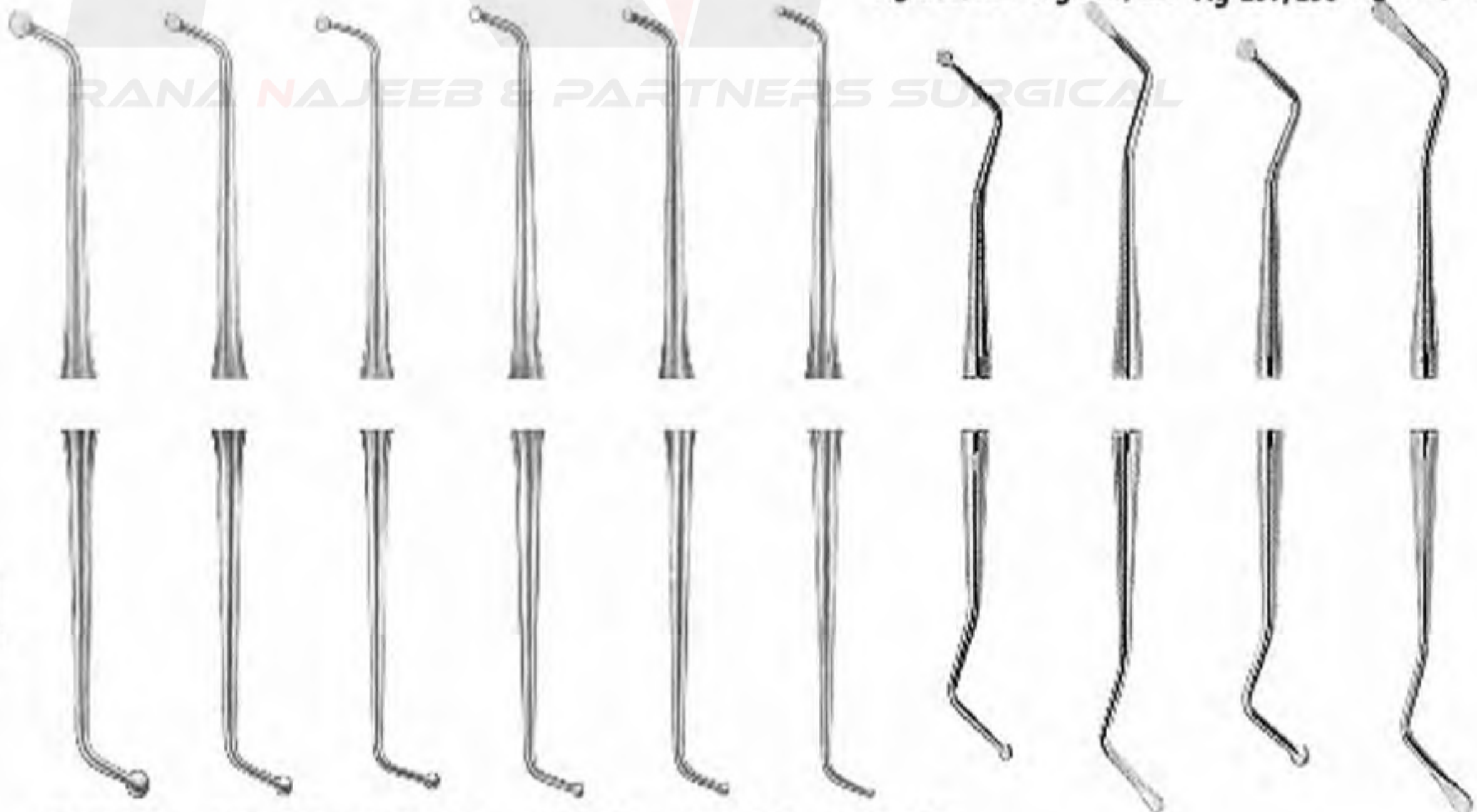

**RP-836** Fig-153/154    **RP-837** Fig-155/156    **RP-838** Fig-157/158    **RP-839** Fig-159/160

**RP830** Fig-113/14    **RP831** Fig-115/116    **RP832** Fig-117/118    **RP833** Fig-119/120    **RP834** Fig-121/122    **RP-835** Fig-123/124

**English Pattern**

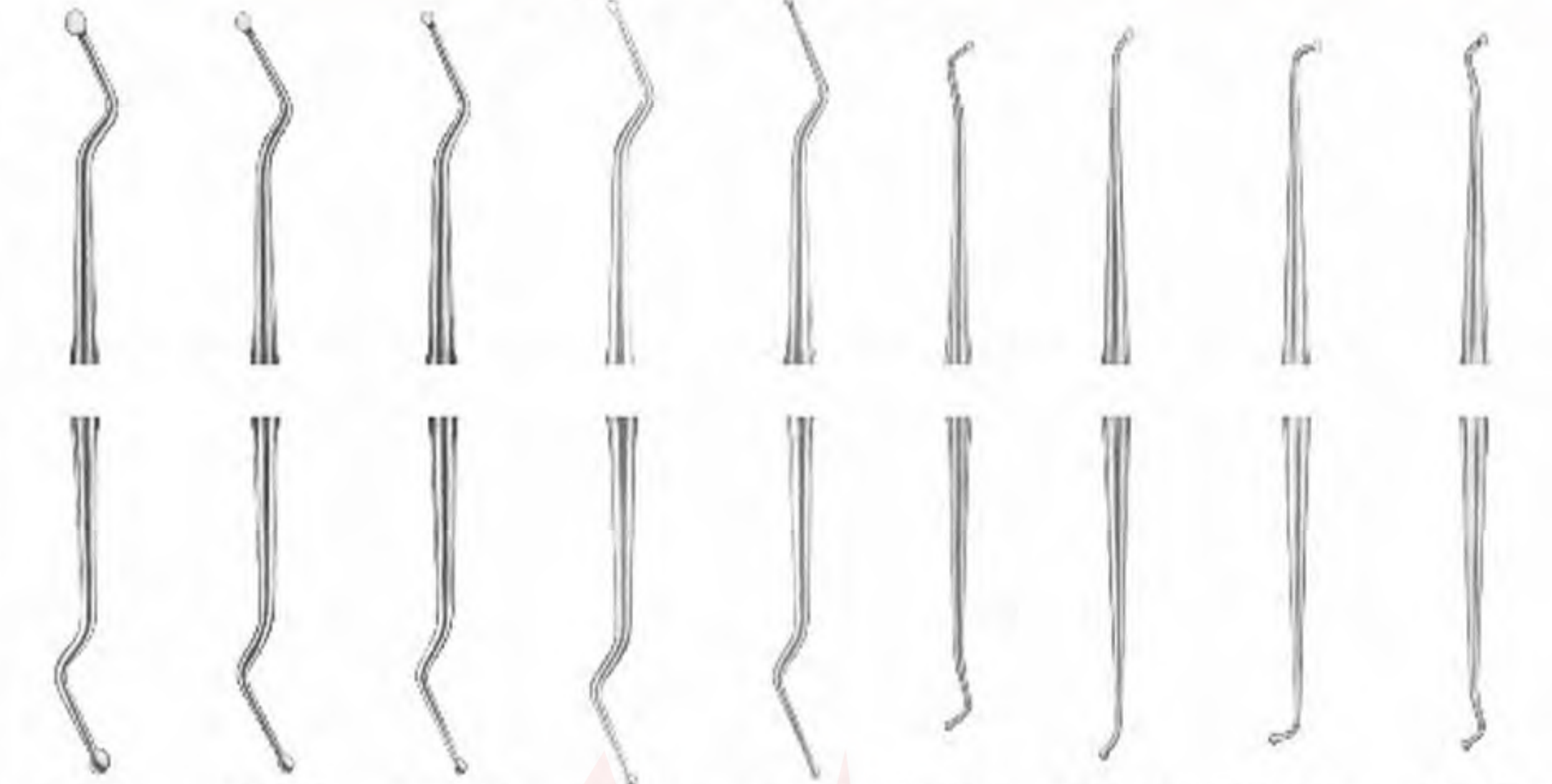

**RP840** Fig-125/126   
 **RP841** Fig-127/128   
 **RP842** Fig-129/130   
 **RP843** Fig-131/132   
 **RP844** Fig-133/134   
 **RP845** Fig-9/10   
 **RP846** Fig-204/205   
 **RP847** Fig-206/207   
 **RP848** Fig-208/209



**RP840**  
Fig-125/126

**RP849** Fig-210/211   
 **RP850** Fig-212/213   
 **RP851** Fig-214/215   
 **RP852** Fig-216/217   
 **RP853** Fig-218/219   
 **RP854** Fig-220/221   
 **RP855** Fig-243   
 **RP856** Fig-244   
 **RP857** Fig-245   
 **RP858** Fig-246





**RP-859**  
**Fig-M9**  
**Molt**

**RP-860**  
**Fig-1**  
**Hopkins**

**RP-861**  
**Fig-2**  
**Hopkins**

**RP-862**  
**Fig-3**  
**Mead**

**RP-863**  
**Fig-PR3**  
**Prichard**

**RP-864**  
**Fig-15**  
**Freer**

**RP-865**  
**Fig-16**  
**Freer**



**RP-866**  
**Fig-12 CA**

**RP-867**  
**Fig-12 A**

**RP-868**  
**Fig-12**  
**Howard**

**RP-869**  
**Fig-33**

**RP-870**  
**Fig-45**  
**Miller**



**RP-871**  
**Fig-1**  
**Wahi**

**RP-872**  
**Fig-2**  
**Wahi**

**RP-873**  
**Fig-1**  
**Polokoff**

**RP-874**  
**Fig-64**  
**Miller**

**RP-875**  
**Fig-10**

**Periodontia Instruments**



**RP876**  
**Fig-1**  
**Hemingway**



<b>RP877</b> <b>Fig-2</b> <b>Hemingway</b>	<b>RP878</b> <b>Fig-3</b> <b>Hemingway</b>	<b>RP879</b> <b>Fig-4</b> <b>Hemingway</b>	<b>RP880</b> <b>Fig-85</b> <b>Lucas</b>	<b>RP881</b> <b>Fig-86</b> <b>Lucas</b>	<b>RP882</b> <b>Fig-87</b> <b>Lucas</b>	<b>RP883</b> <b>Fig-88</b> <b>Lucas</b>
--	--	--	---	---	---	---



<b>RP884</b> <b>Fig-1S/2S</b> <b>Sugarman</b>	<b>RP885</b> <b>Fig-3S/4S</b> <b>Sugarman</b>	<b>RP886</b> <b>Fig-9/10</b> <b>Schlugar</b>	<b>RP887</b> <b>Fig-11/12</b> <b>Buck</b>	<b>RP888</b> <b>Fig-3</b> <b>Ochsenbein</b>	<b>RP889</b> <b>Fig-4</b> <b>Ochsenbein</b>	<b>RP890</b> <b>Fig-36/37</b> <b>Rhodes</b> <b>Back-Action</b>
---	---	--	---	---	---	---

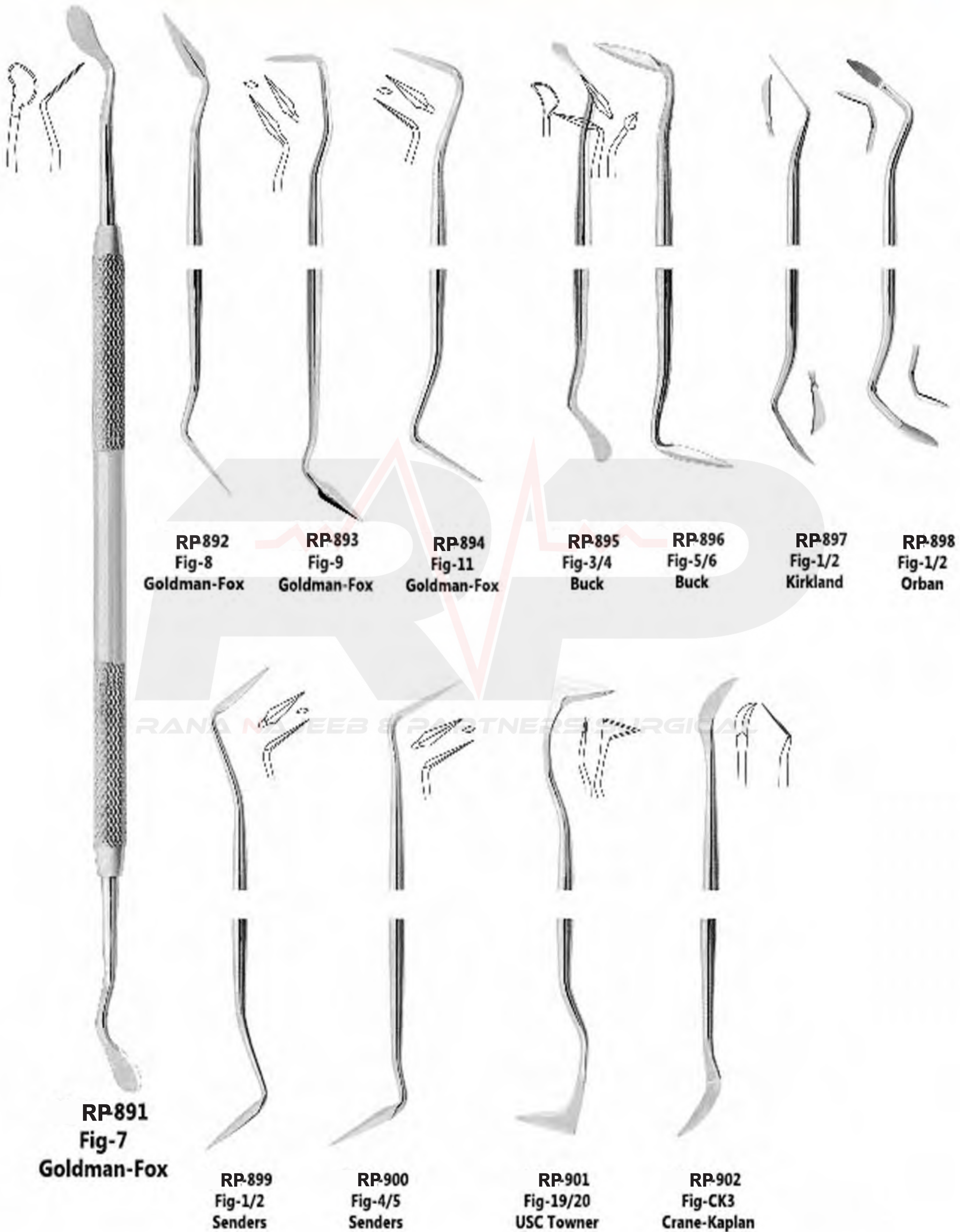

**Curettes & Scalers**

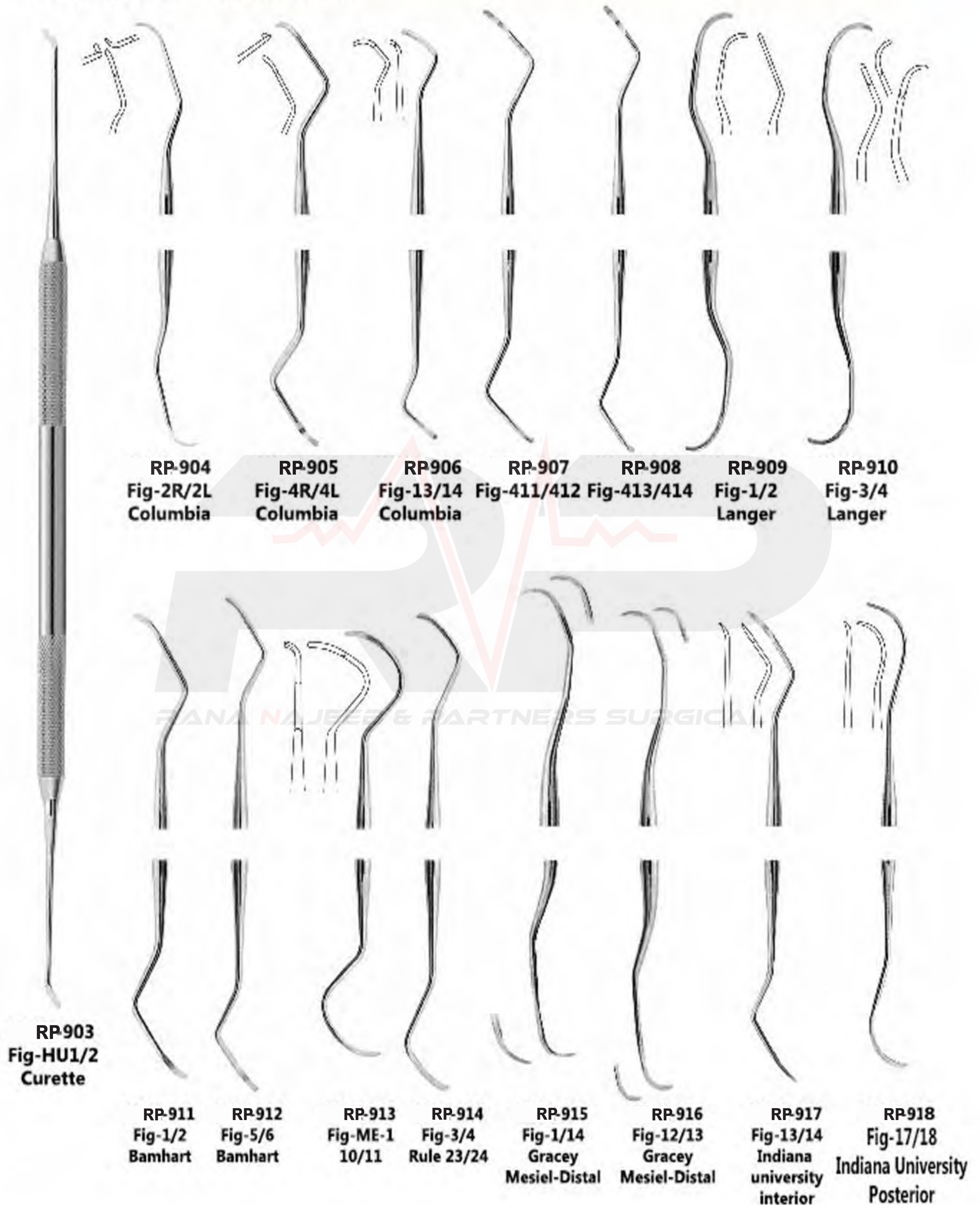

**RP-904**  
Fig-2R/2L  
Columbia

**RP-905**  
Fig-4R/4L  
Columbia

**RP-906**  
Fig-13/14  
Columbia

**RP-907**  
Fig-411/412

**RP-908**  
Fig-413/414

**RP-909**  
Fig-1/2  
Langer

**RP-910**  
Fig-3/4  
Langer

**RP-903**  
Fig-HU1/2  
Curette

**RP-911**  
Fig-1/2  
Bamhart

**RP-912**  
Fig-5/6  
Bamhart

**RP-913**  
Fig-ME-1  
10/11

**RP-914**  
Fig-3/4  
Rule 23/24

**RP-915**  
Fig-1/14  
Gracey  
Mesial-Distal

**RP-916**  
Fig-12/13  
Gracey  
Mesial-Distal

**RP-917**  
Fig-13/14  
Indiana  
university  
interior

**RP-918**  
Fig-17/18  
Indiana University  
Posterior

SET OF 7 O-025-280S

**Gracey Curettes**

SET OF 9 O-025-286 AS

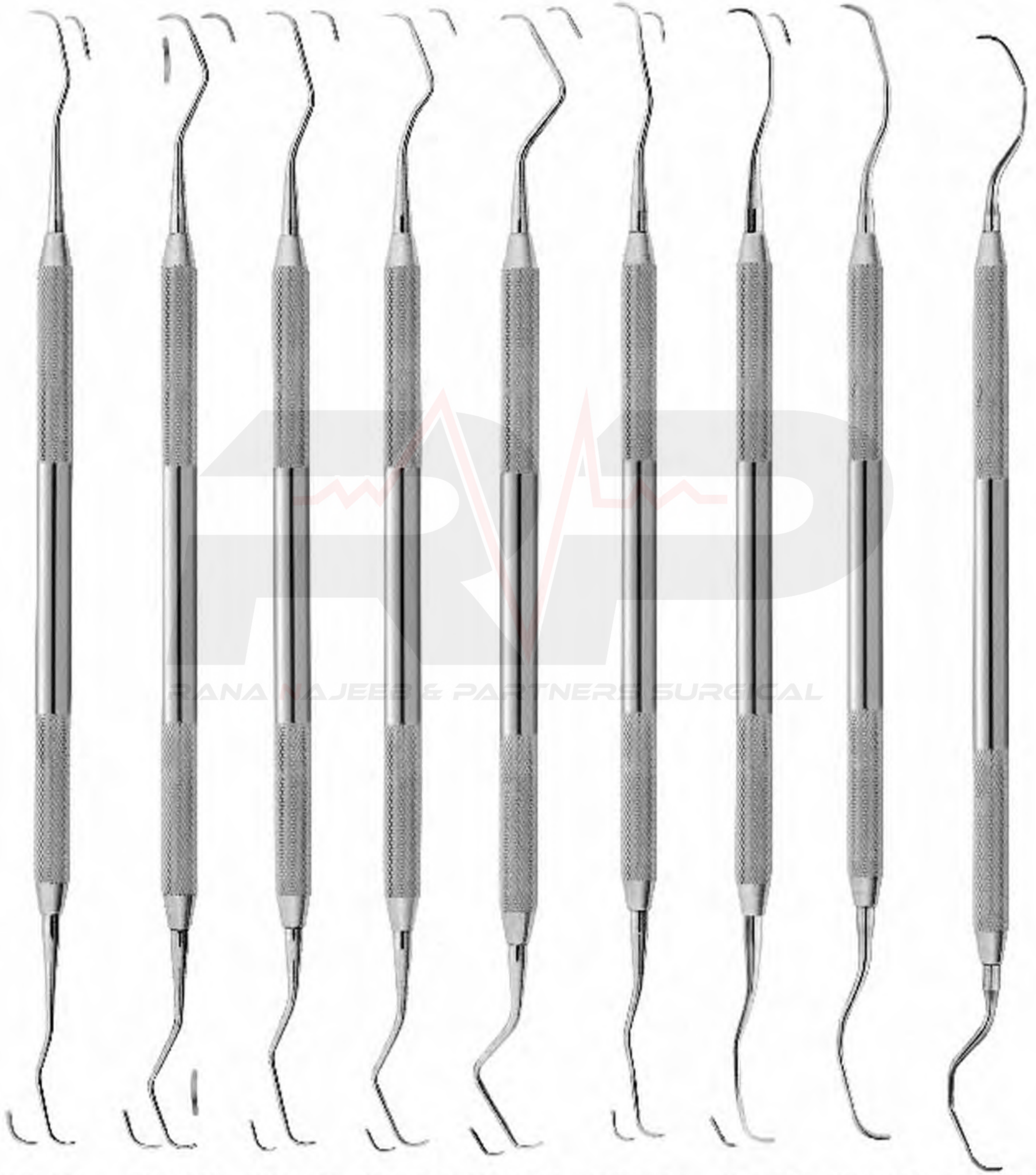

**RP-919**  
Fig-1/2  
Gracey

**RP-920**  
Fig-3/4  
Gracey

**RP-921**  
Fig-5/6  
Gracey

**RP-922**  
Fig-7/8  
Gracey

**RP-923**  
Fig-9/10  
Gracey

**RP-924**  
Fig-11/12  
Gracey

**RP-925**  
Fig-13/14  
Gracey

**RP-926**  
Fig-15/16  
Gracey

**RP-927**  
Fig-17/18  
Gracey

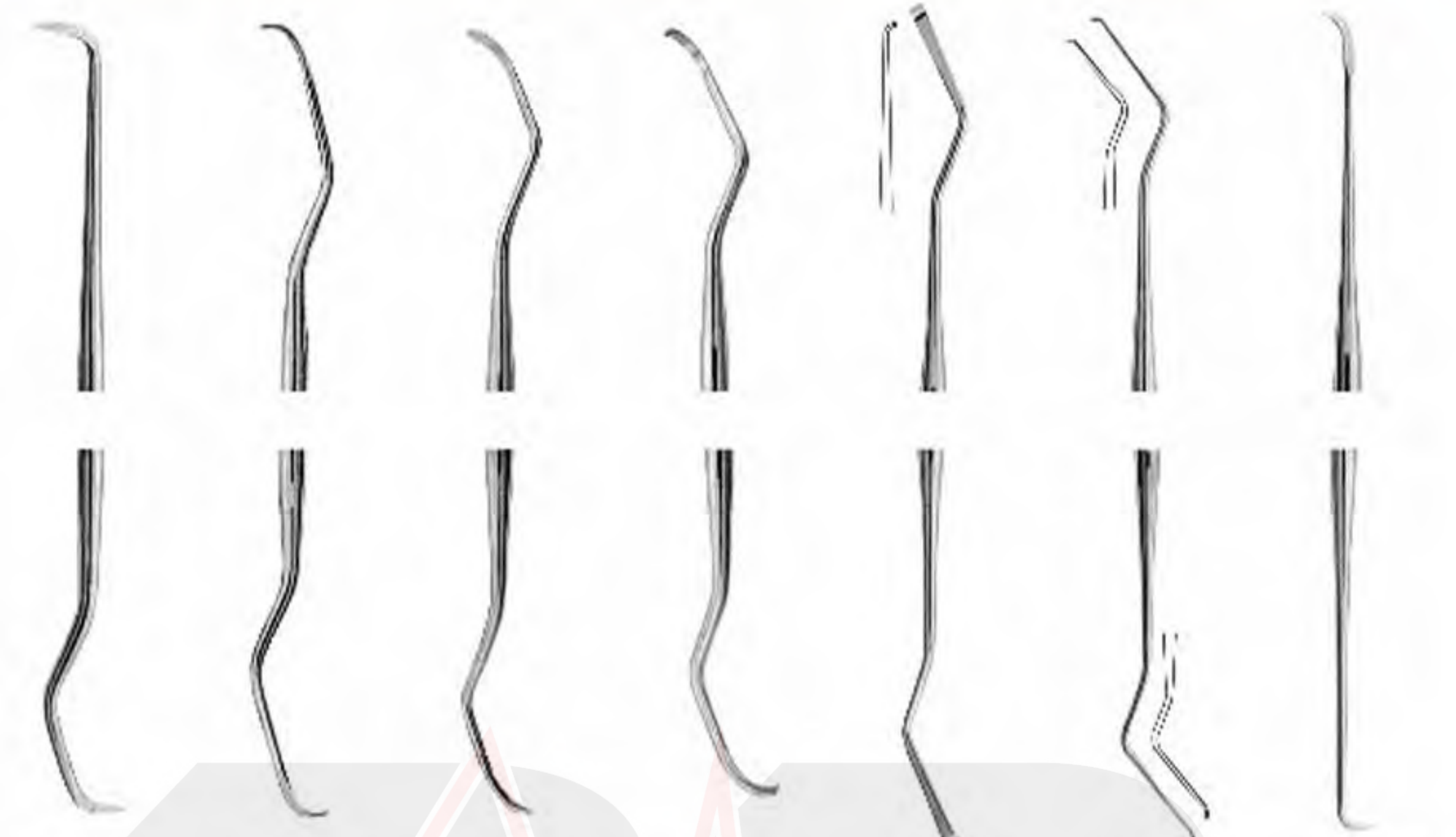

<b>RP929</b> Fig-1 Goldman-Fox	<b>RP930</b> Fig-2 Goldman-Fox	<b>RP931</b> Fig-3 Goldman-Fox	<b>RP932</b> Fig-4 Goldman-Fox	<b>RP933</b> Fig-5 Goldman-Fox	<b>RP934</b> Fig-6 Goldman-Fox	<b>RP935</b> Fig-21 Goldman-Fox
--------------------------------------	--------------------------------------	--------------------------------------	--------------------------------------	--------------------------------------	--------------------------------------	---------------------------------------



<b>RP928</b> Fig-1 De Marco	<b>RP936</b> Fig-2 De Marco	<b>RP937</b> Fig-11/12 Mc Call	<b>RP938</b> Fig-11A/12A Mc Call	<b>RP939</b> Fig-13/14 Mc Call	<b>RP940</b> Fig-13S/14S Mc Call	<b>RP941</b> Fig-17S/18S Mc Call	<b>RP942</b> Fig-19/20 Mc Call
-----------------------------------	-----------------------------------	--------------------------------------	--	--------------------------------------	--	--	--------------------------------------





<b>RP944</b> Fig-30/33 Jaquette	<b>RP945</b> Fig-31/32 Jaquette	<b>RP946</b> Fig-34/35 Jaquette	<b>RP947</b> Fig-37/38 Jaquette	<b>RP948</b> Fig-U15/33 Towner Jaquette	<b>RP949</b> Fig-U15/30 Towner Jaquette	<b>RP950</b> Fig-H5/33	<b>RP951</b> Fig-H65/H7
---------------------------------------	---------------------------------------	---------------------------------------	---------------------------------------	--	--	---------------------------	----------------------------

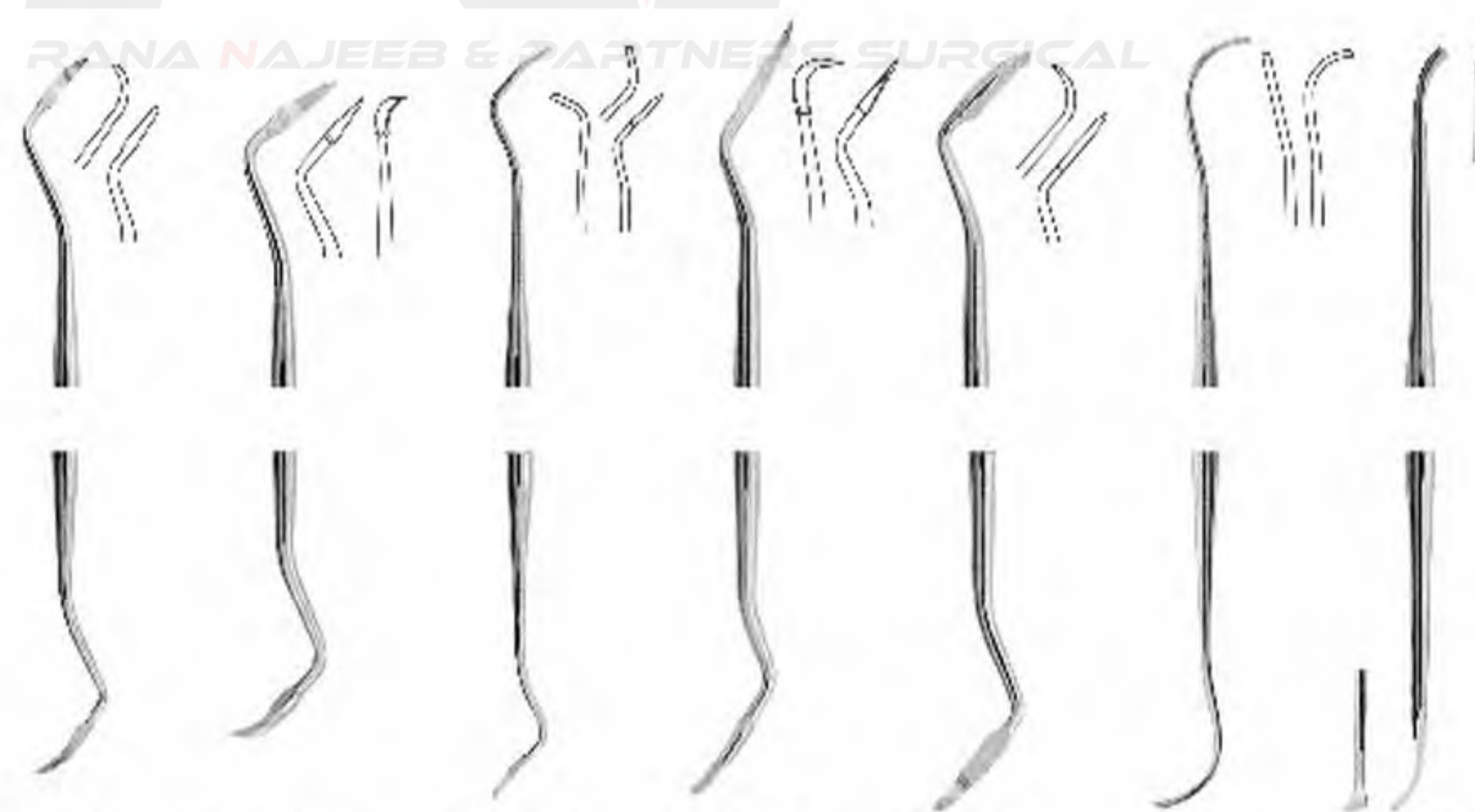

<b>RP943</b> Fig-3/7 Hirschfeld	<b>RP952</b> Fig-2/3 Taylor	<b>RP953</b> Fig-204	<b>RP954</b> Fig-204S	<b>RP955</b> Fig-2/3	<b>RP956</b> Fig-6 Crane-Kaplan	<b>RP957</b> Fig-7/8 Younger Good	<b>RP958</b> Fig-1/2
---------------------------------------	-----------------------------------	-------------------------	--------------------------	-------------------------	---------------------------------------	---	-------------------------

## Scalers



**RP-959**  
Fig-33



**RP-960**  
Fig-31



**RP-961**  
Fig-32



**RP-962**  
Fig-34



**RP-963**  
Fig-35



**RP-964**  
Fig-H5  
Hygienist



**RP-965**  
Fig-H6  
Hygienist



**RP-966**  
Fig-H7  
Hygienist



**RP-967**  
Fig-1



**RP-968**  
Fig-1L  
Sinistro



**RP-969**  
Fig-1R  
Destro



**RP-970**  
Fig-2L  
Sinistro



**RP-971**  
Fig-2R  
Destro



**RP-972**  
Fig-U15  
Towner



**RP-973**  
Fig-U15  
Zerfing-Chisel



**RP-974**  
Fig-1  
Kirkland



**RP-975**  
Fig-2  
Kirkland



**RP-976**  
Fig-1  
Orban



**RP-977**  
Fig-2  
Orban



**RP-978**  
Fig-1  
TG Chisel



**RP-979**  
Fig-2  
TG Chisel

## Heidemann Separating Spatulas



**RP980**

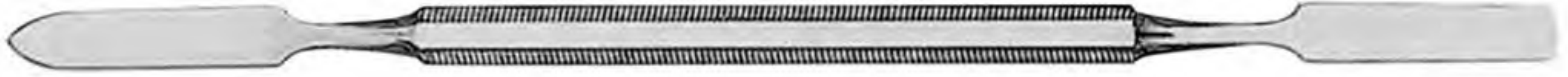

**RP981**

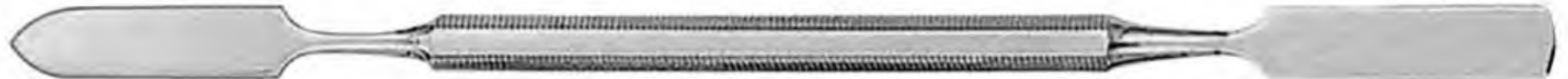

**RP982**



**RP983**



**RP984**



**RP985**



**RP986**



**RP987**



**RP988**  
**Fig-1**

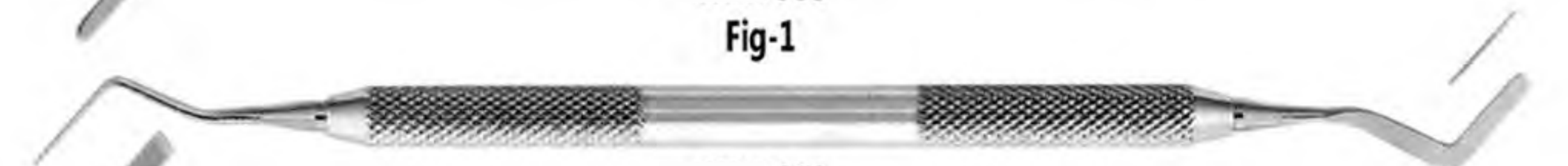

**RP989**  
**Fig-2**

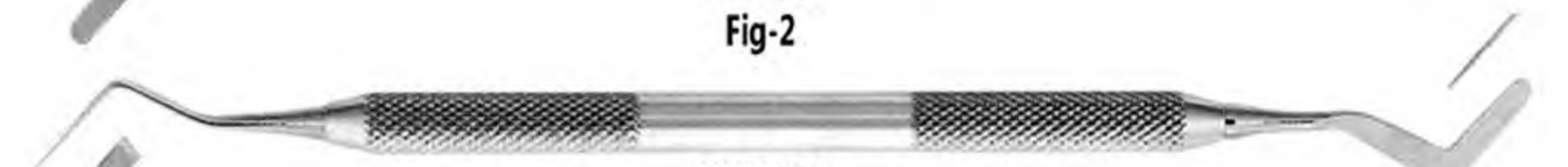

**RP990**  
**Fig-3**



**RP-991**  
Zehle

**RP-992**  
Zehle

**RP-993**  
Zehle

**RP-994**  
Hylin

**RP-995**  
Hylin-Ceramica

**RP-996**  
Hylin-Sacred

**RP-997**  
Hylin-Le-Cron

**RP-998**  
Sacred



**RP-999**  
Le Cron



**RP-1000**  
Le Cron



**RP-1001**  
Vehe



**RP-1002**  
Beale



**RP-1003**  
Roach



**RP-1004**  
Le Cron



**RP-1005**  
Le Cron



**RP-1006**  
Gritman



**RP-1007**  
**Fig-1**  
P.K.Thams



**RP-1008**  
**Fig-2**  
P.K.Thams



**RP-1009**  
**Fig-3**  
P.K.Thams



**RP-1010**  
**Fig-4**  
P.K.Thams



**RP-1011**  
**Fig-5**  
P.K.Thams





**RP-1012**  
**Fig-1**  
**Fahnenstock**  
cm. 12,5

**RP-1013**  
**Fig-1**  
**Lessmann**  
cm. 12,5

**RP-1014**  
**Fig-1**  
**Con Scodellino**  
cm. 12,5

**RP-1015**  
**Fig-1**  
**Fahnenstock**  
cm. 17

**RP-1016**  
**Fig-1**  
**Lessmann**  
cm. 17

**RP-1017**  
**Fig-1**  
**Cos Scodellino**  
cm. 17



**RP-1018**  
cm. 17



**RP-1019**  
cm. 17 Gritman



**RP-1020**  
cm. 19,5



**RP-1021**  
cm. 21,5



**RP-1022**  
cm. 20,5



**RP-1023**  
cm. 19,5



**RP-1024**  
cm. 20



**RP-1025**  
cm. 22,5



# AMALGAM CARVERS



**RP-1026**  
Small

**RP-1027**  
Medium

**RP-1028**  
Large

**RP-1029**  
Jumbo



**RP-1030**  
Amalgam Well



**RP-1031**  
Medium/Small

**RP-1032**  
Medium/Large

**RP-1033**  
Medium/Jumbo



**RP-1034**

**RP-1035**

**RP-1036**



**RP1037**  
Intraligmentary Syringe



**RP-1038**  
Cartridge Syringe



**RP1039**  
Aspirated Syringe  
1,8 ml



**RP1040**  
Aspirated Syringe  
1,8 ml



**RP1041**  
Cartridge Syringe  
1,8 ml

Available Threads:-Inches & Matric



**RP-1042**  
 Chip Blower



**RP-1043**



**RP-1044**



**RP-1045**



**RP-1046**  
 Firm Holders for  
 10 Films

**RP-1047**  
 6 Films

**RP-1048**  
 14 Films



**RP-1049**  
 Water Syringe



**RP-1050**  
 Water Syringe



**RP-1051**  
 Napkin Holder With Plastic  
 Band

**RP-1052**  
 Napkin Holder With Metal Chain

RANA NAJEEB & PARTNERS SURGICAL

# MATRIX RETAINERS



**RP-1053** 5mm  
**RP-1054** 6mm  
**RP-1055** 7mm  
Ivory 8

**RP-1056**  
Ivory 8 N

**RP-1057**  
Ivory 8

**RP-1058**  
Siqueland Narrow  
**RP-1059**  
Siqueland Wide

**RP-1060**  
Fig-1  
Tofflemire  
Universal

**RP-1061**  
Fig-3  
Tofflemire  
Senior

**RP-1062**  
Fig-2  
Tofflemire  
Junior



**RP-1063**  
Fig-2  
Didner 8P

**RP-1064**  
Ivory

**RP-1065**  
Ivory

**RP-1066**  
Ivory  
Separator



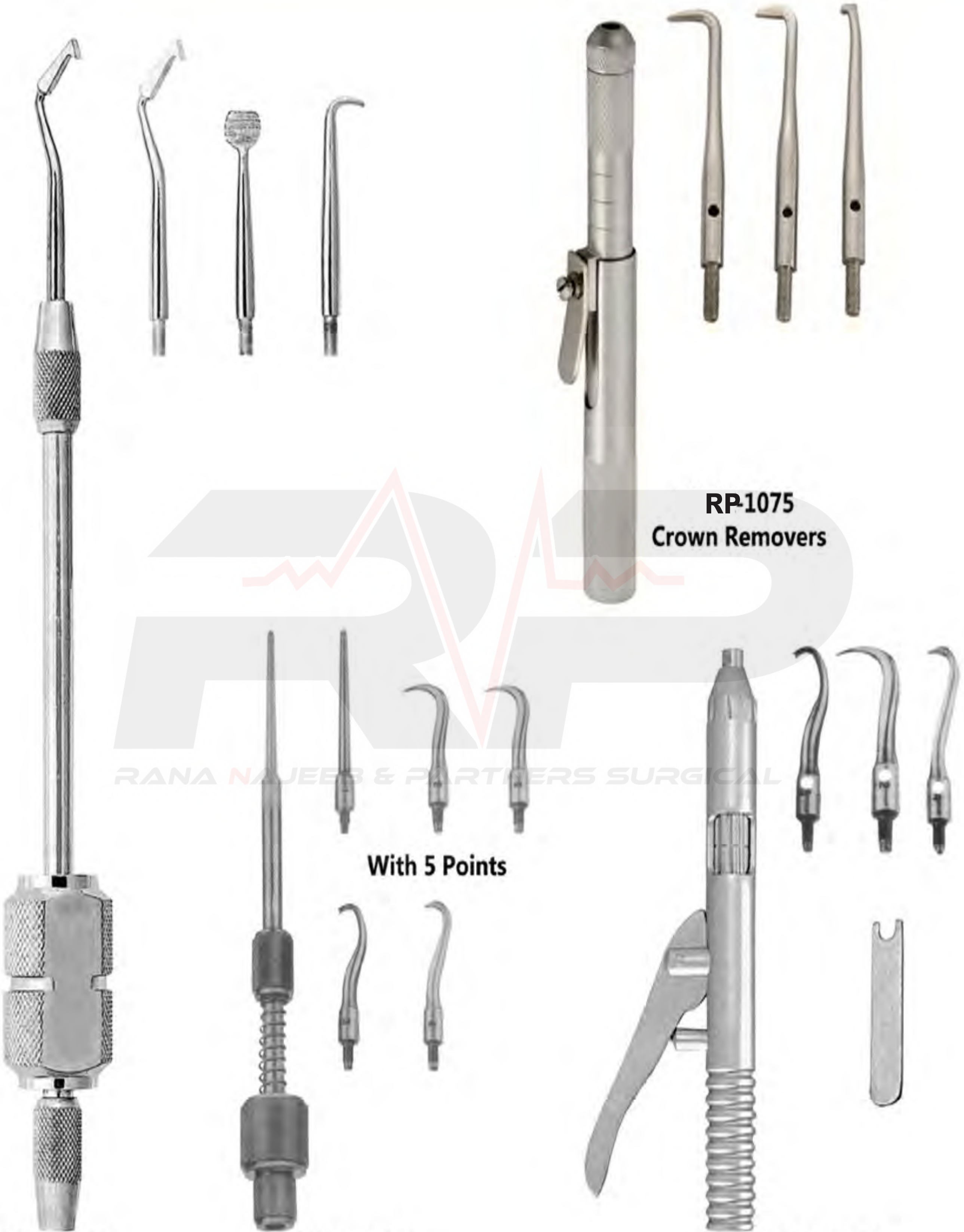

**RP-1075**  
Crown Removers

**With 5 Points**

**RP-1076**  
Crown Removers

**RP-1077**  
Crown Removers

**RP-1078**  
Crown Removers

# Plastic Cutting Plier



**RP-1079**  
15 CM  
Articulating  
Paper Forceps



**RP-1080**  
Miller  
15 CM



**RP-1081**  
Crown Spreader



**RP-1082**  
17 cm  
**WAK-1083**  
20 cm  
Plaster Cutting Plier

# STAINLESS STEEL IMPRESSION TRAYS

**Solid Partial Set  
of 10 225-001S**

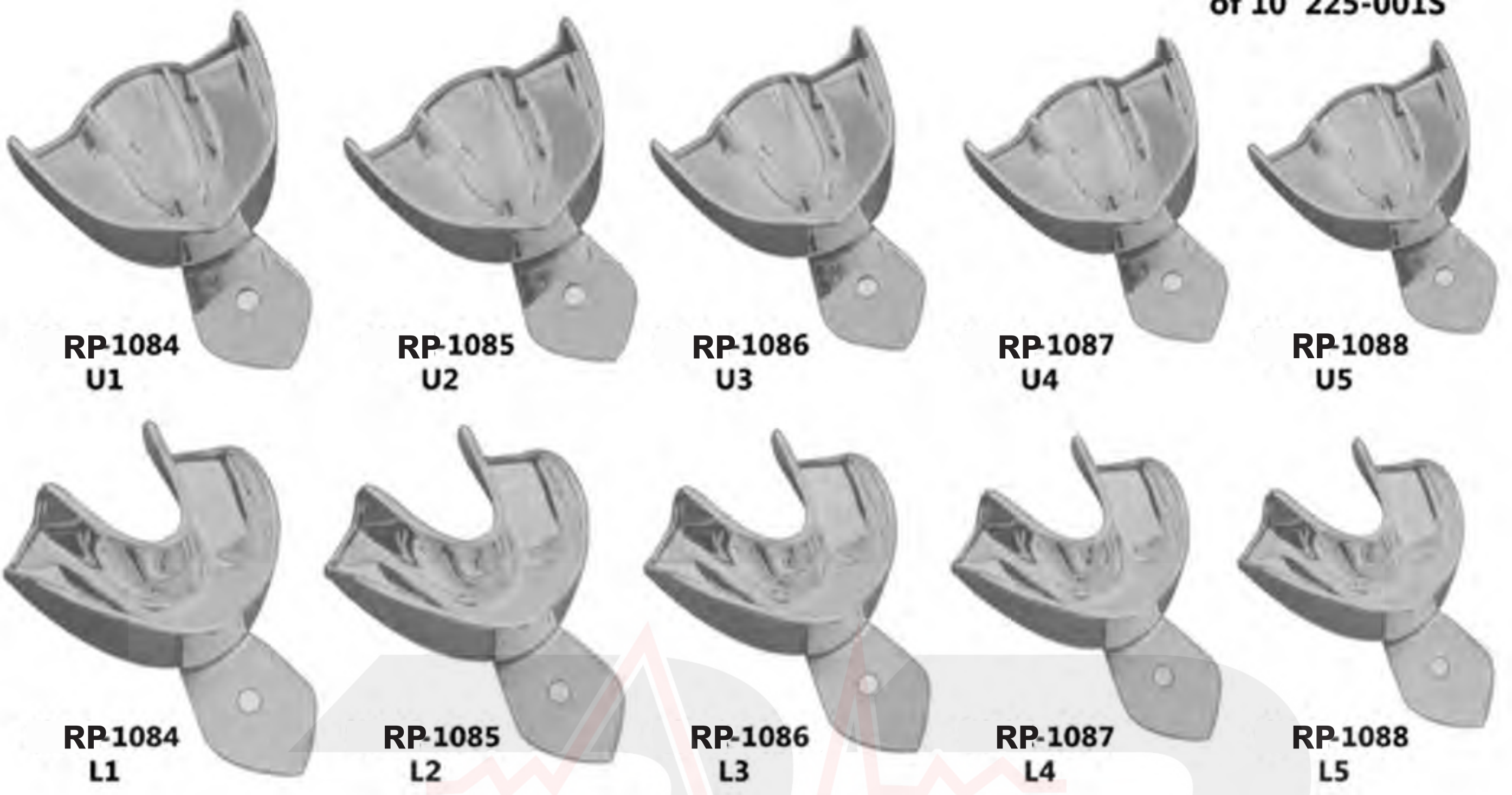

All the above impression trays are available in these 5 sizes

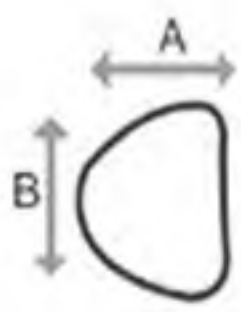

UPPER		U1	U2	U3	U4	U5
	A		62	60	53	54
B		85	75	73	69	68

All Dimension are in mm

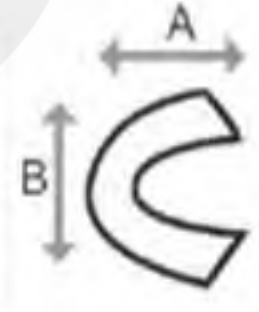

LOWER		L1	L2	L3	L4	L5
	A		62	60	53	54
B		85	75	73	69	68

All Dimension are in mm

RANA NAJEEB & PARTNERS SURGICAL

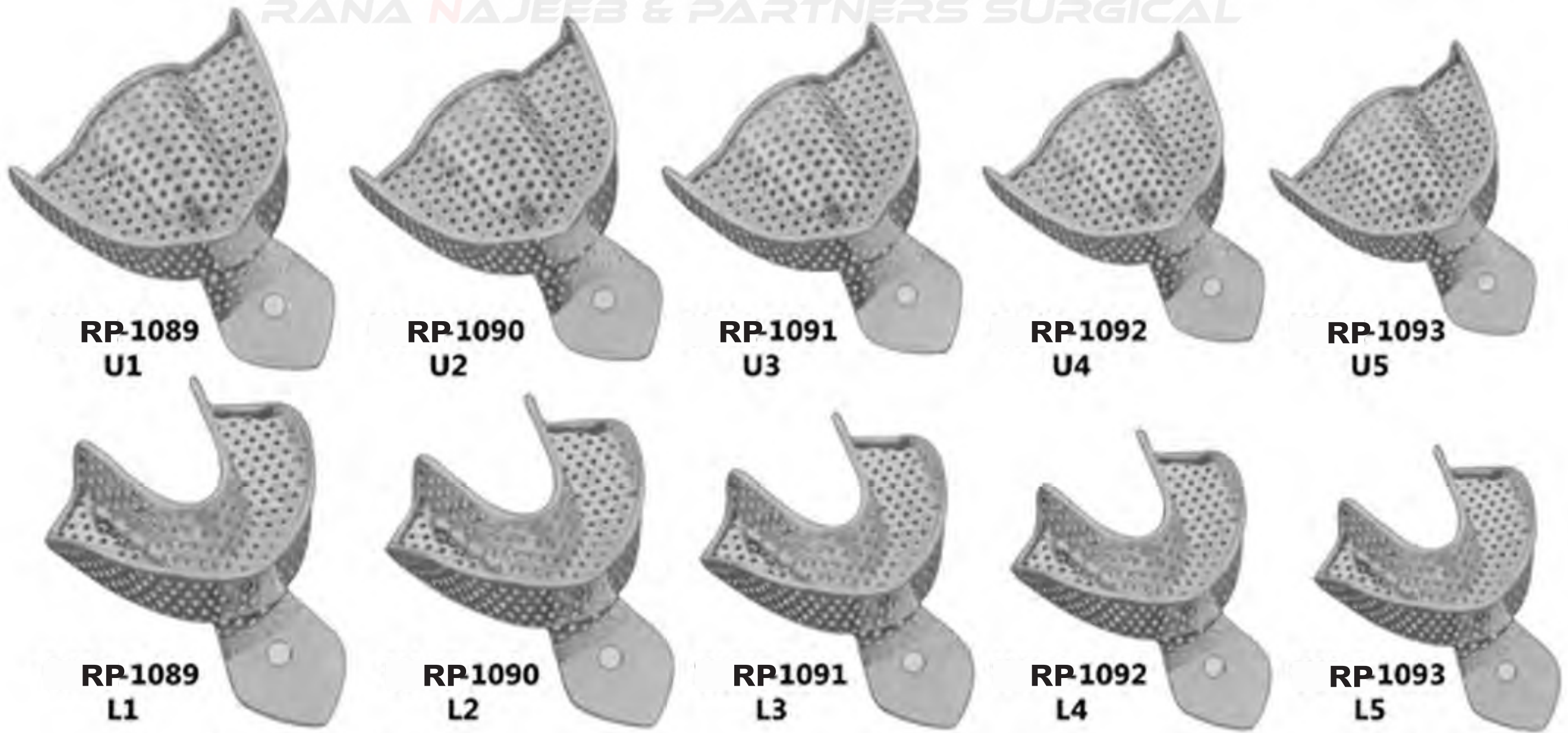

**Perforated Partial Set  
of 10 225-001S**



# STAINLESS STEEL IMPRESSION TRAYS

## Solid Full Denture Set of 8 225-011S

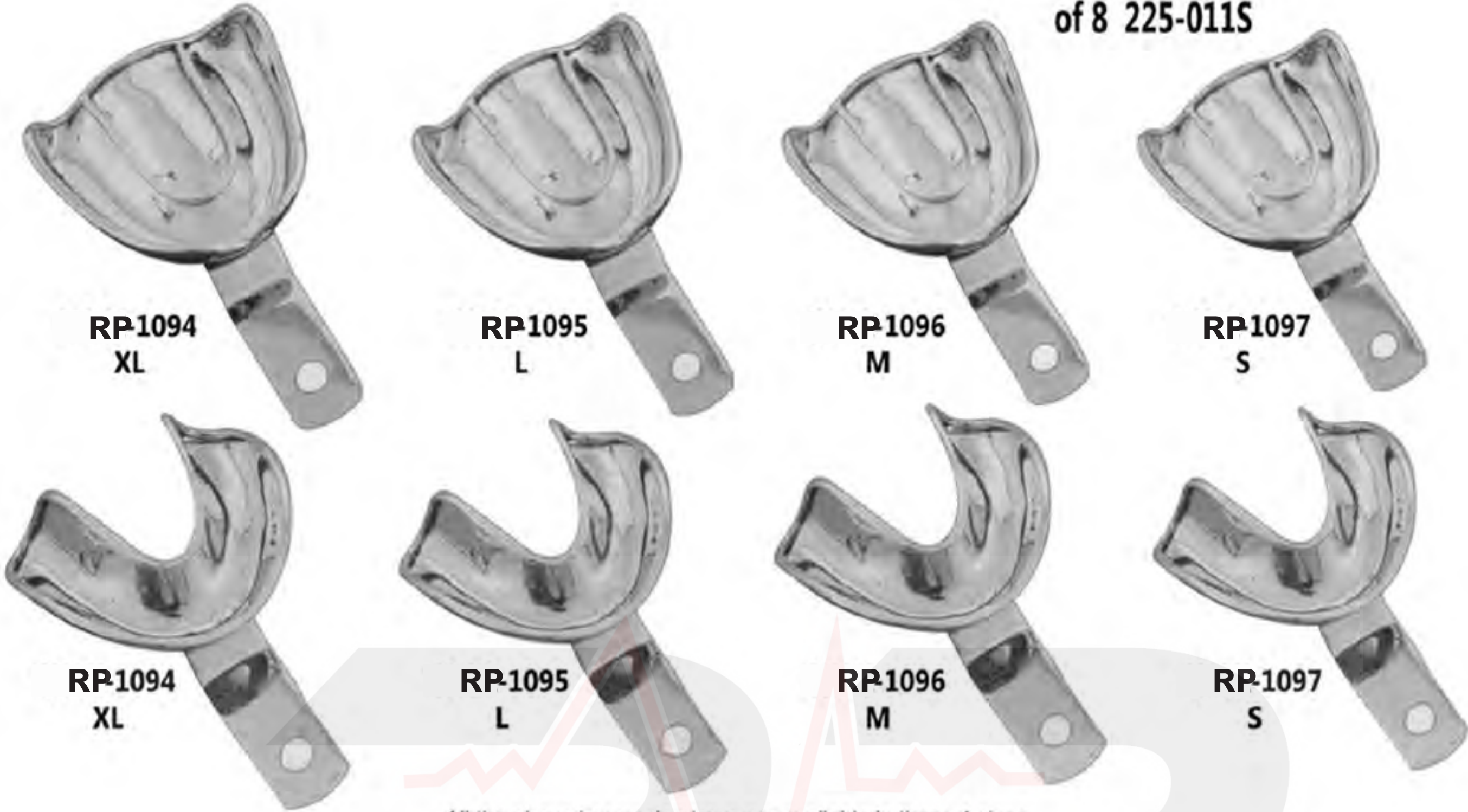

All the above impression trays are available in these 4 sizes

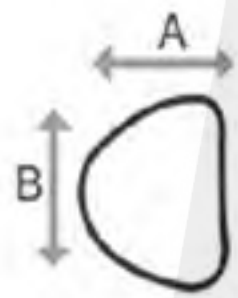

UPPER		XL	L	M	S
	A	70	67	64	60
B	79	76	70	73	

All Dimension are in mm



LOWER		XL	L	M	S
	A	64	64	60	57
B	86	70	73	70	

All Dimension are in mm



## Perforated Full Denture Set of 8 225-018S

## Solid Set pf 6



**RP1102  
U1**



**RP1103  
U2**



**RP1104  
U3**



**RP1102  
L1**



**RP1103  
L2**



**RP1104  
L3**

All the above impression trays are available in these 3 sizes

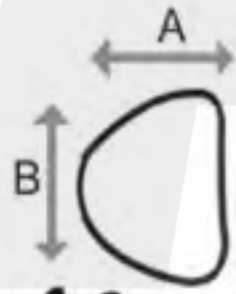

UPPER		U 1	U 2	U 3
	A	67	64	57
B	81	71	70	

LOWER		L 1	L 2	L 3
	A	60	57	54
B	81	79	76	



All Dimension are in mm

All Dimension are in mm

## Perforated Set pf 6



**RP1105  
U1**



**RP1106  
U2**



**RP1107  
U3**



**RP1105  
L1**



**RP1106  
L2**



**RP1107  
L3**

## English Pattern

Set of 8



**RP-1108  
Lower**



**RP-1108  
Upper**

## Mesh Trays

Set of 8



**Punched Type**



**RP-1109  
Upper**

Set of 8



**RP-1110  
Lower**

## Solid Type



**RP-1110  
Upper**

All the above impression trays are available in these 3 sizes

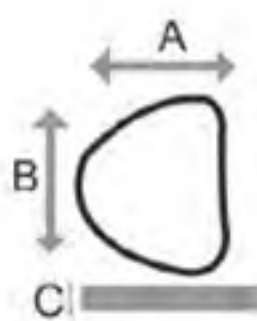

UPPER	Size	A	B	C
	0	67	50	12
	1	72	51	13
	2	78	55	15
	3	80	58	15

All Dimension are in mm

LOWER	Size	A	B	C
	0	70	50	14
	1	77	51	15
	2	79	55	15
	3	80	60	17

All Dimension are in mm

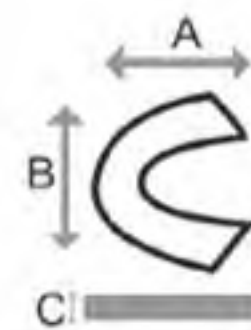

## Solid Full Denture Set of 8



**RP1111**  
XL



**RP1112**  
L



**RP1113**  
M



**RP1114**  
S



**RP1111**  
XL



**RP1112**  
L



**RP1113**  
M



**RP1114**  
S

All the above impression trays are available in these 3 sizes

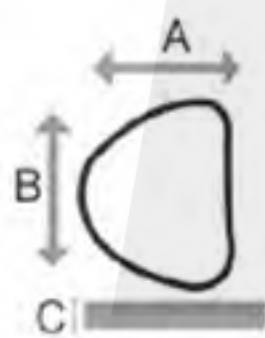

UPPER		XL	L	M	S
	A	70	67	64	60
B	79	76	70	73	

All Dimension are in mm

LOWER		XL	L	M	S
	A	64	64	60	57
B	86	70	73	70	

All Dimension are in mm



## Perforated Full Denture Set pf 8



**RP1115**  
XL



**RP1116**  
L



**RP1117**  
M



**RP1118**  
S



**RP1115**  
XL



**RP1116**  
L



**RP1117**  
M



**RP1118**  
S

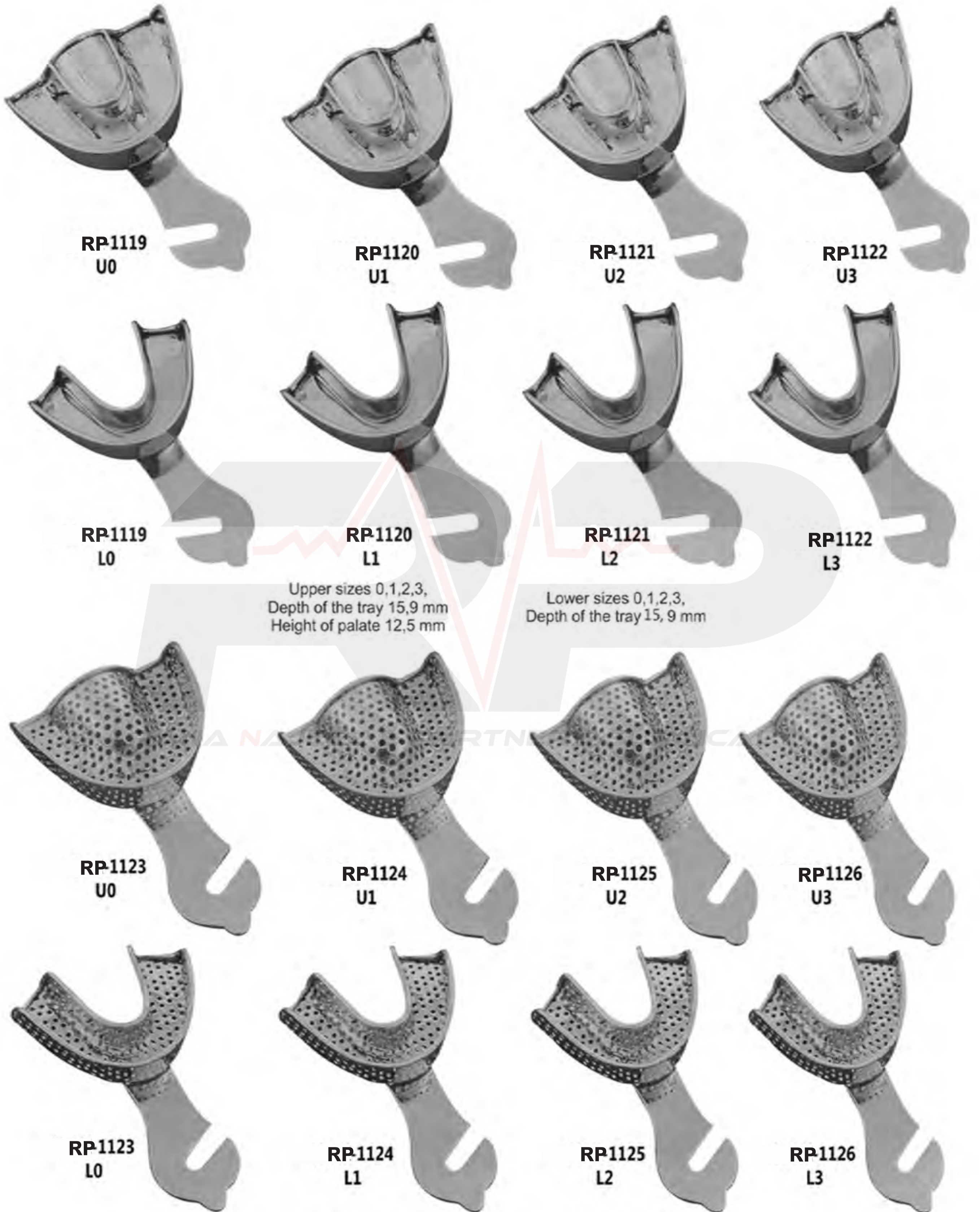

**Perforated Full Denture Set of 8**

**Impression Trays For Crown & Bridge Work**



**RP1127  
U1P**

**RP1127  
L1P**

**RP-1128  
U1P**

**RP-1128  
U1P**



**RP1129**  
For upper right jaw  
For lower left jaw

**RP1130**  
For upper left jaw  
For lower right jaw

**RP-1131**  
Adjustable  
Perforated

**RP-1131A**  
Adjustable  
Solid

Available in 4 Sizes

- 1..... 44 mm
- 2..... 55 mm
- 3..... 60 mm
- 4..... 65 mm

Also available in Solid pattern

complete Instruments tray with Perforated base, Lid & insert frame for 16 instrument



**RP-1132**

Lid: Dimensions mm, 288\*187\*29

complete Instruments tray with Perforated base, Lid & insert frame for 23 instrument



**RP-1136**

Lid: Dimensions mm, 288\*187\*29

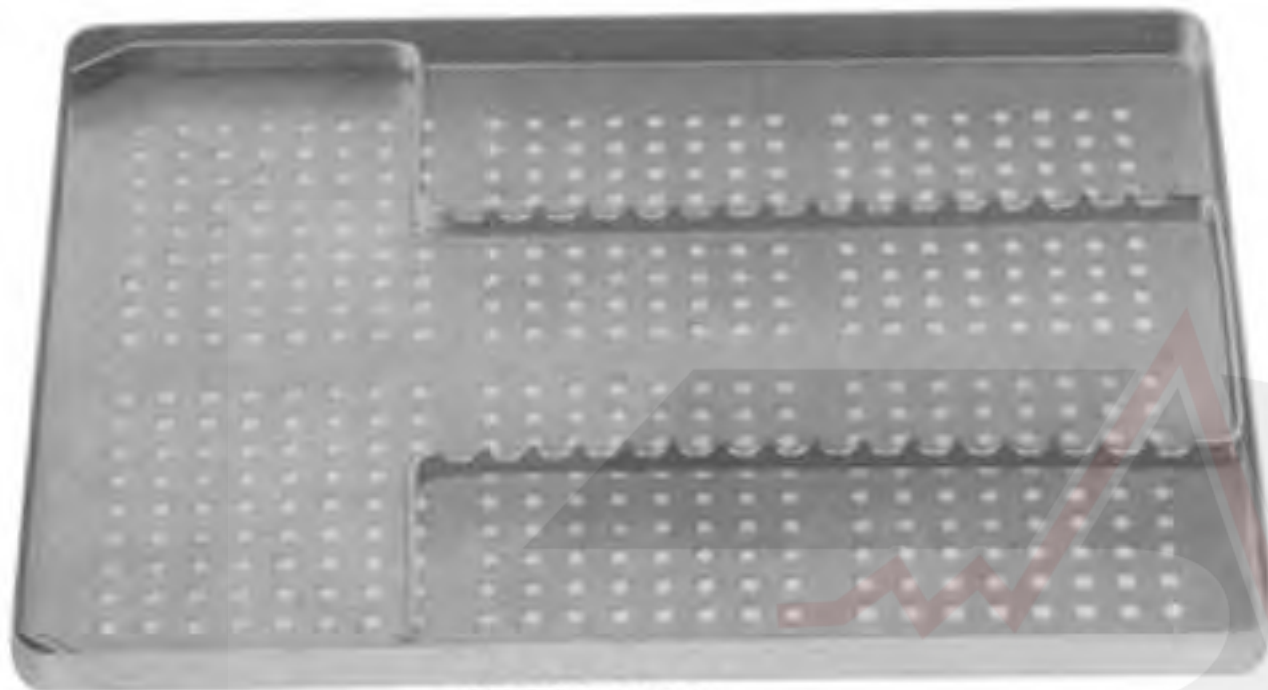

**RP-1133**

Perforated Base: Dimensions mm, 284\*183\*17

complete Instruments tray with Solid base, Lid & insert frame for 16 instrument

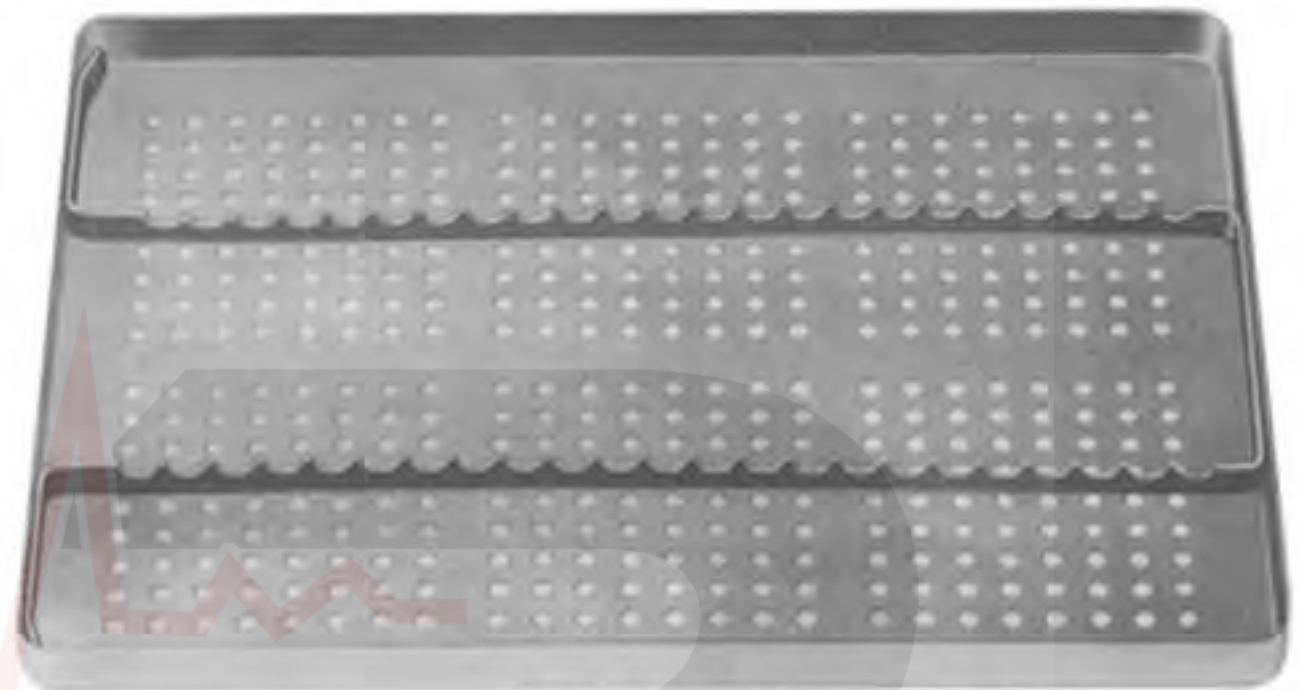

**RP-1137**

Perforated Base: Dimensions mm, 284\*183\*17

complete Instruments tray with Solid base, Lid & insert frame for 23 instrument



**RP-1134**

Lid: Dimensions mm, 288\*187\*29



**RP-1138**

Lid: Dimensions mm, 288\*187\*29

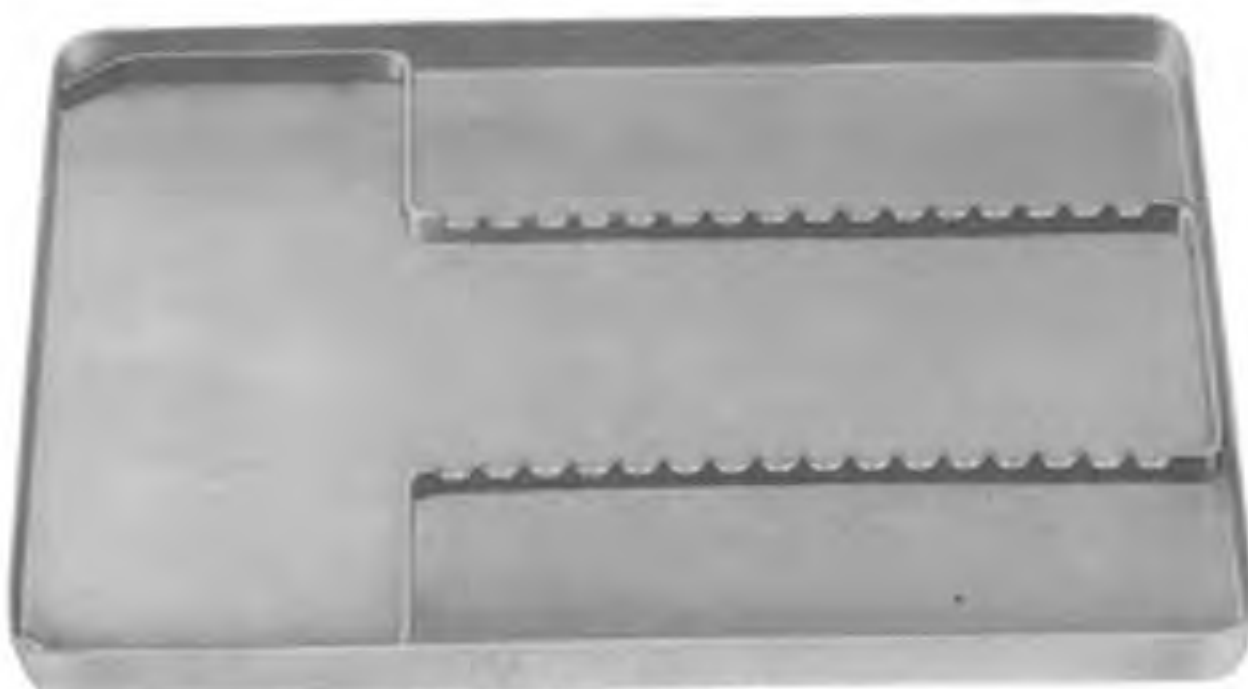

**RP-1135**

Solid Base: Dimensions mm, 284\*183\*17

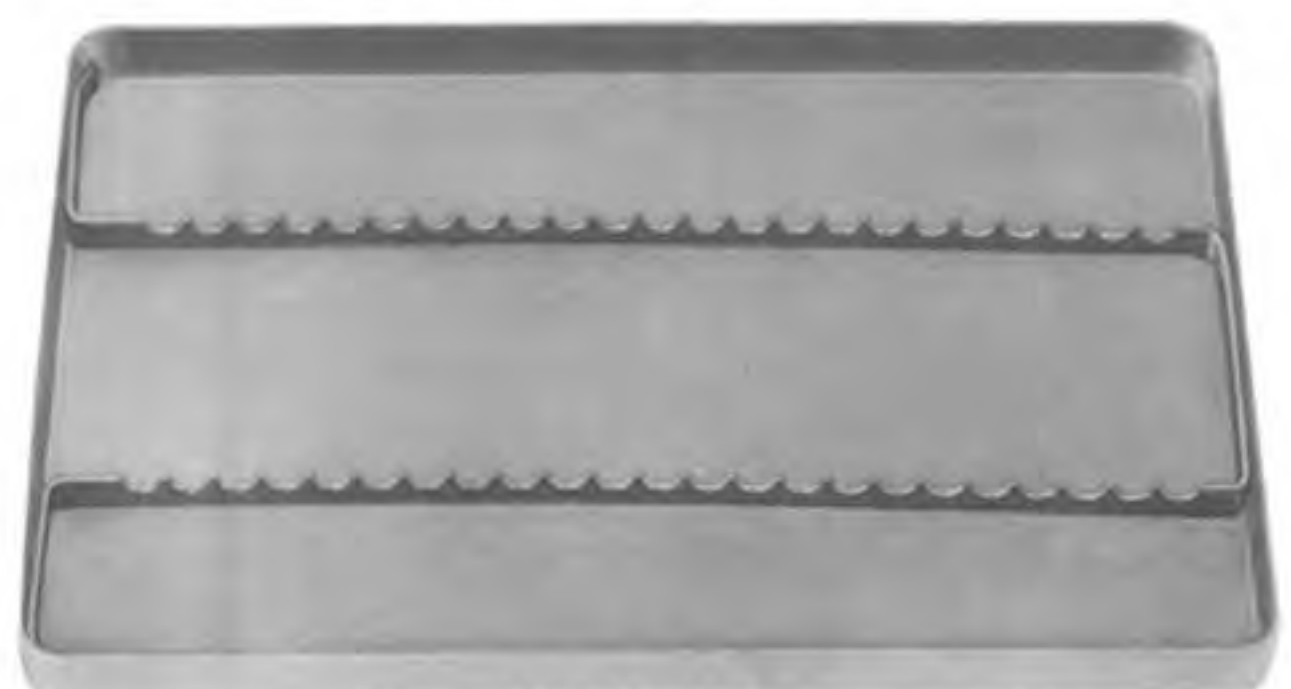

**RP-1139**

Solid Base: Dimensions mm, 284\*183\*17

**Scalars Trays**



**RP-1140**



**RP-1141**  
**6"\*10"**



**RP-1142**  
**6"\*8"**  
**With Lid**

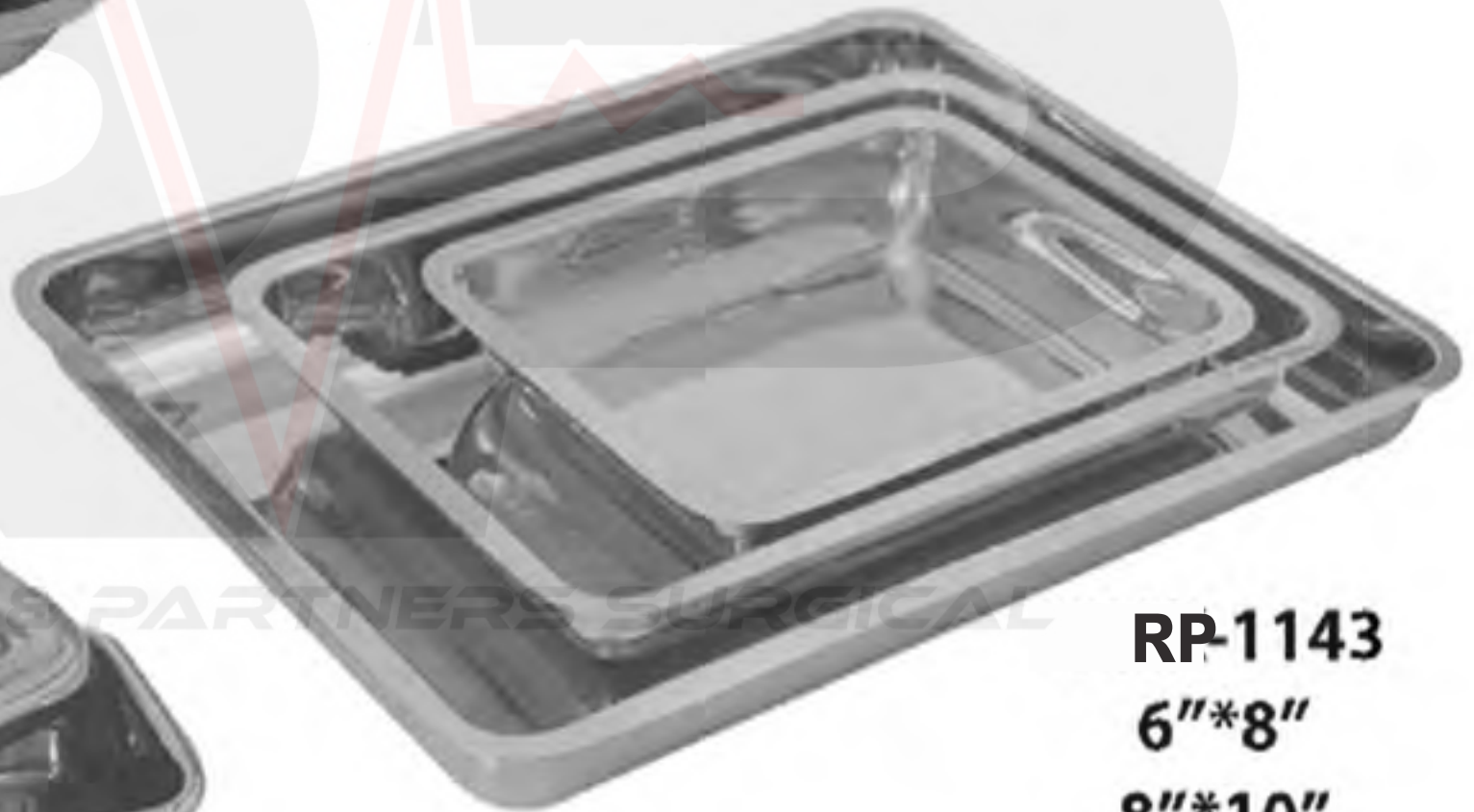

**RP-1143**  
**6"\*8"**  
**8"\*10"**  
**10"\*12"**



**RP-1144**



**RP-1145**  
**Endodontic box**  
**Also available in solid pattern**



**RP-1146**  
**8"\*12"**  
**With Lid**





**Deep**

**RP-1147**  
2.25"\*2"  
4.75"\*2"  
5.5"\*2.5"  
6.25"\*2.75"  
7"\*3.5"

**Kidney Trays**



**RP-1148**  
12", 10", 8", 6"



**RP-1149**  
6"\*9"\*8"\*12"

**Shallow**



**RP-1150**  
10"\*10"

**Round Bowls**



**RP-1151**  
Cotton Holder



**RP-1152**  
80 \* 35 mm  
125 \* 60 mm

**RP-1155**  
Forceps Jar



25 \* 80 mm  
30 \* 100 mm  
100 \* 200 mm  
75 \* 173 mm



**RP-1153**  
Spirit Lamp



**RP-1154**  
Spirit Lamp



**RP-1156**  
**Fig-30**



**RP-1157**  
**Fig-31**



**RP-1158**  
**Fig-51**



**RP-1159**  
**Fig-138**



**RP-1160**  
**Fig-139**



**RP-1161**  
**Fig-15**



**RP-1162**  
**Fig-18**



**RP-1163**  
**Fig-24**



**RP-1164**  
**Fig-25**



**RP-1165**  
**Fig-26**



**RP-1166**  
**Fig-28**

**Bicuspid Clamps Winged**



**RP-1167**  
**Fig-206**



**RP-1168**  
**Fig-207**



**RP-1169**  
**Fig-208**



**RP-1170**  
**Fig-209**



**RP-1171**  
**Fig-22**



**RP-1172**  
**Fig-27**



**RP-1173**  
**Fig-29**

**Molar Clamps Winged**



**RP-1174**  
**Fig-26A**



**RP-1175**  
**Fig-28A**



**RP-1176**  
**Fig-30A**



**RP-1177**  
**Fig-31A**



**RP-1178**  
**Fig-51A**

**Bicuspid Clamps Winged**



**RP-1179**  
**Fig-27**



**RP-1180**  
**Fig-29**



**RP-1181**  
**Fig-60**

**Molar Clamps Winged**



**RP-1182**  
**Fig-200**



**RP-1183**  
**Fig-201**



**RP-1184**  
**Fig-202**



**RP-1185**  
**Fig-203**



**RP-1186**  
**Fig-204**



**RP-1187**  
**Fig-205**

**Labial Clamps Winged**



**RP-1188**  
**Fig-210**



**RP-1189**  
**Fig-211**



**RP-1190**  
**Fig-212**

**RP-1195**  
**How Plier**  
Firmly hold the bracket tie wing for seating of the band.  
Carbide serrated tips for non grip. 49.50



**RP-1191**  
**De Bonding Plier**  
Bracket / Adhesive remove with replaceable tool steel tip. wedge between both edges of the base of the bracket lifting and tooth surface. Easily lifting off the bracket or Bonding material. 49.50



**RP-1196**  
**Jara Back Plier**  
A Plier for precise bending of wires. Precision grooves ensure accurate bending and closing of loops. Serrated tip for up to .020" wires. 49.50



**RP-1192**  
**Posterior Band Remover Long**  
The padded tip rest on the Occlusal of the molar and the carbide tipped side removes the bracket or Bonding material. 49.50



**RR-1197**  
**Hard Wire Cutter**  
Cuts hard wire up to .020" carbide insert for longer life. 49.50



**RP-1193**  
**Posterior Band Remover Small**  
49.50



**RP-1198**  
**Pin & Ligature Cutter**  
Standard size lips designed to cut soft wire up to .051". 49.50



**RP-1194**  
**Tweed Loop Forming Plier**  
3 Size carbide tip allows to make 3 size loops. Can hold wire firmly upto .022" x .028"  
The other side serrated tip gives non slip grip. 49.50



All Pliers Also Available In Box Joint

**RP-1203**  
**Bird Beak Plier**  
1/2" Long tip carbide inserted round tip and flat ground tip gives non slip grip for wire up to .030". 49.50



**RP--1199**  
**Angled Direct Bond Bracket Remover**  
60° Angled tip allows for easy access to difficult anterior and posterior areas. 49.50

**RP-1204**  
**Safety hold, small Distal end Cutter**  
Narrow and light. 49.50

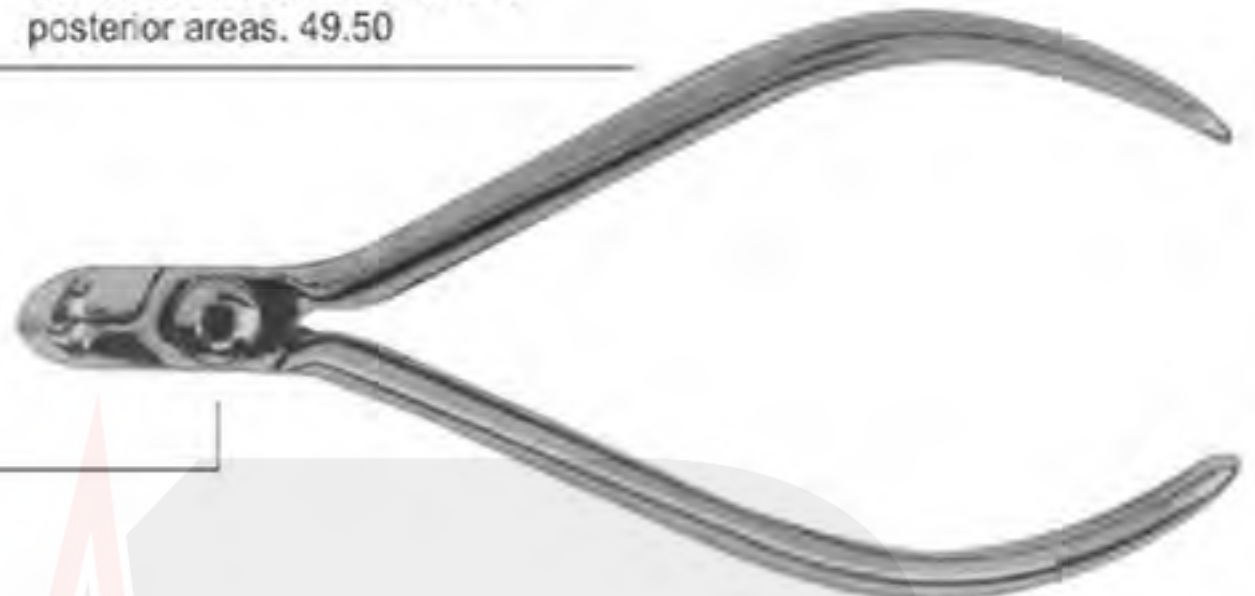

**RP1200**  
**Weingart Utility Plier**  
Matching deep serrated pads holds wire firmly at a convex working angle. Tapered narrow lip fits easily between brackets. 4950

**RR-1205**  
**Safety hold, Distal end Cutter**  
Carbide tips for longer life and sharpness cuts and hold wire up to .022" x .028". 49.50



**RP-1201**  
**Three Prong Clasps Adjusting Plier**  
Rounded jaws close and adjust clasps without niking wire upto .030". 49.50

**RP-1206**  
**Mini Pin & Ligature Cutter**  
Narrow tips cuts pins, Ligatures and elastic smoothly and soft wire up to .015". 49.50



**RP-1202**  
**Light Wire Plier**  
Wire forming Plier upto .061" the longer tapered beaks make it easier to bend small diameter loops. 3Groves on square tip. 49.50



**Weingart style plier**  
13 cm / 5"

786-1213 Box Joint  
786-1214 Screw Joint  
786-1215 L-Key Joint  
Classical design, rounded tips.  
Useful for removal of ceramics.



**Rectangular Arch plier**  
13 cm / 5"

786-1216 Box Joint  
786-1217 Screw Joint  
786-1218 L-Key Joint  
Short jaws, Tweed style, for use  
with square or rectangular wires.  
Blades parallel at 0.02", 0.05"



**Arch forming &  
contouring plier**  
13 cm / 5"

786-1219 Box Joint  
786-1220 Screw Joint  
786-1221 L-Key Joint  
With 3 grooves,  
For wire 0.016", 0.018" & 0.022".



**Arch forming plier**  
13 cm / 5"

786-1222 Box Joint  
786-1223 Screw Joint  
786-1224 L-Key Joint  
Without grooves



**Arch contouring plier**  
13 cm / 5"

786-1225 Box Joint  
786-1226 Screw Joint  
786-1227 L-Key Joint  
for easily forming arches.

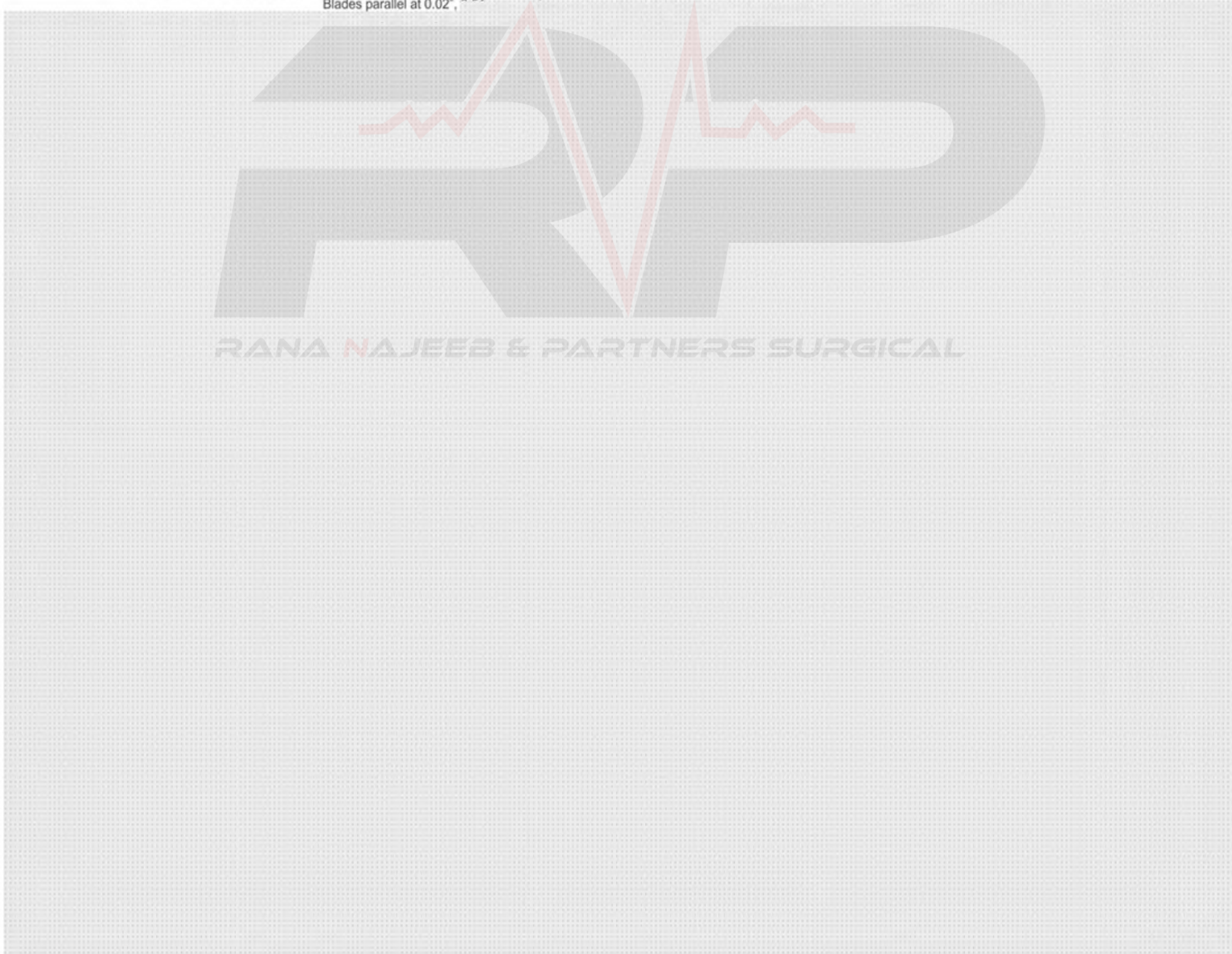



**RP-1207**  
Full Arch  
Chrome Plated



**RP-1208**  
Crowend Bridge  
Chrome Plated



**RP-1209**  
Full Denture  
Chrome Plated



**RP-1210**  
Full Arch  
Chrome Plated



**RP-1211**  
Denture  
Chrome Plated



**RP-1212**

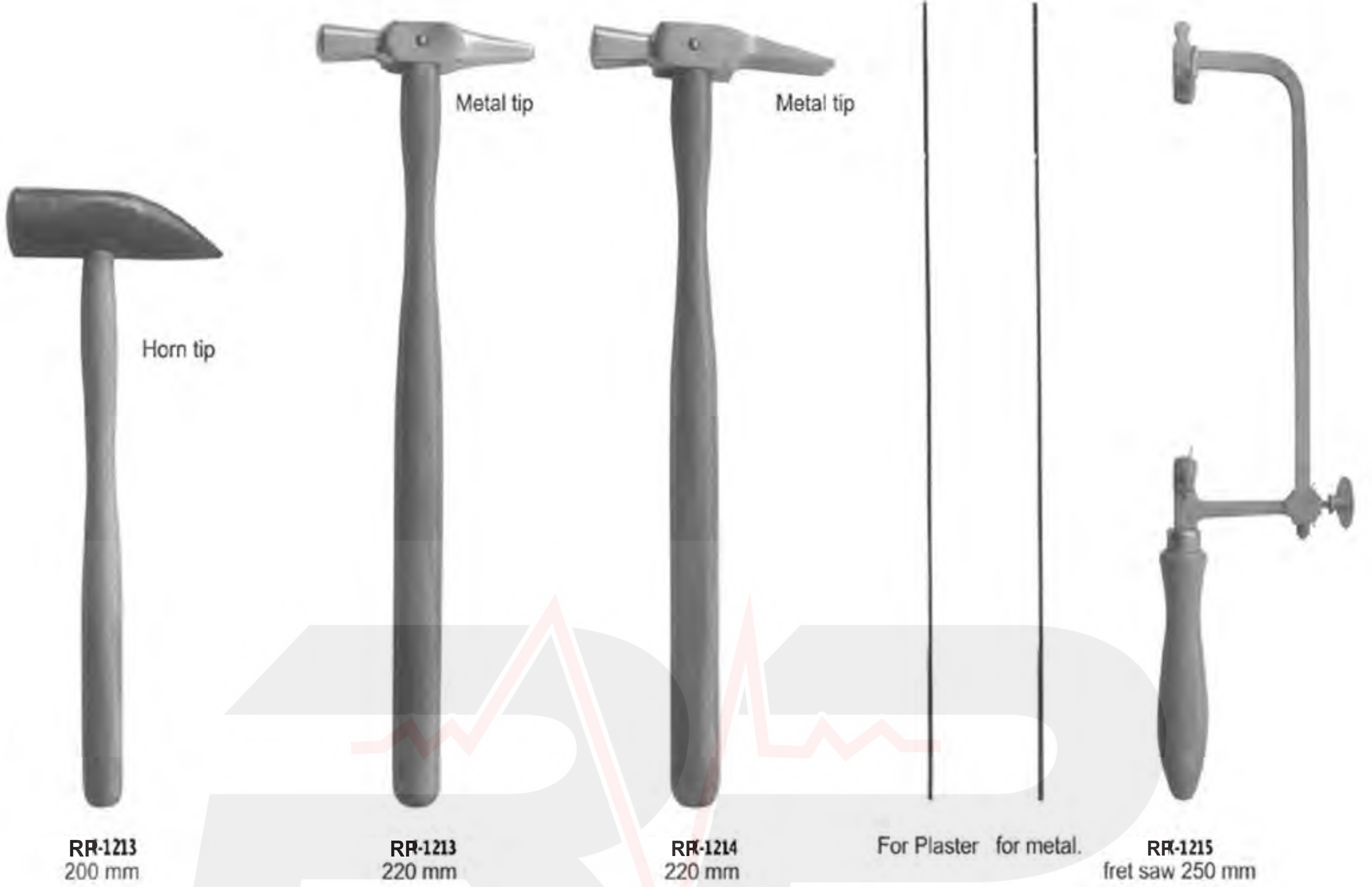

st. steel plaster shears

RANA NAJEEB & PARTNERS SURGICAL



RR-1216  
200 mm



RP-1217 250 mm  
RP-1218 320 mm  
Crucible tongs.



RP-1219  
180 mm

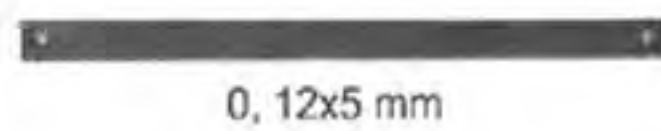

0, 12x5 mm

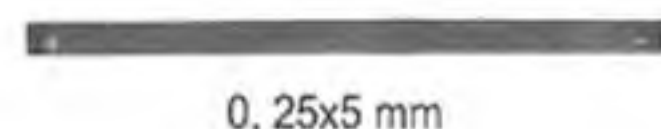

0, 25x5 mm



0, 25x3 mm

# LABORATORY SET



**RR-1220**  
Set of 14 Pieces



**RP-1221**  
Set of 14 Pieces



# TONGUE HOLDING FORCEPS



**RUSSIAN TISSUE FORCEPS**  
 RP-1222 6", 15cm  
 RP-1223 8", 20cm



**MAGILL FORCEPS**  
 RP-1224 Child – 7-1/2", 19cm  
 RP-1225 Adult – 9 3/4", 25cm



**STERILIZING FORCEPS**  
 RP-1226 Straight, 8", 20cm



**YOUNG TONGUE SEIZING FORCEPS**  
 RP-1227 With Rubber Jaws,  
 6-1/4", 16cm  
 RP-1228 Replacement Tips 2/set



**CHISELS**  
 RP-1229  
 5mm Flat Chisel,  
 45° Angle, 6", 15cm

RANA NAJEEB & PARTNERS SURGICAL

**Bracket Holder Tweezers**



**RP-1230**  
X-ray Holder  
Clip Single



**RP-1231**  
Bracket Placer  
Tweezers  
(Extra Fine Tip)



**RP-1232**  
Easy Ecess  
Tweezers



**RP-1233**  
Slipper  
Tweezers



**RP-1234**  
Deluxe Bracket  
Holder Tweezers



**RP-1235**  
Deluxe Bracket  
Holder Tweezers



**RP-1236**  
Bracket Tweezers  
Slot Aligner



**RP-1237**  
Direct bonding  
bracket holders  
135mm



**RP-1238**  
Direct Bond Bracket  
Holder Tweezers



**RP-1239**  
Direct Bond  
Bracket Holder  
Tweezers, Small Tip



**RP-1240**  
Exact Bracket  
Holder Tweezers

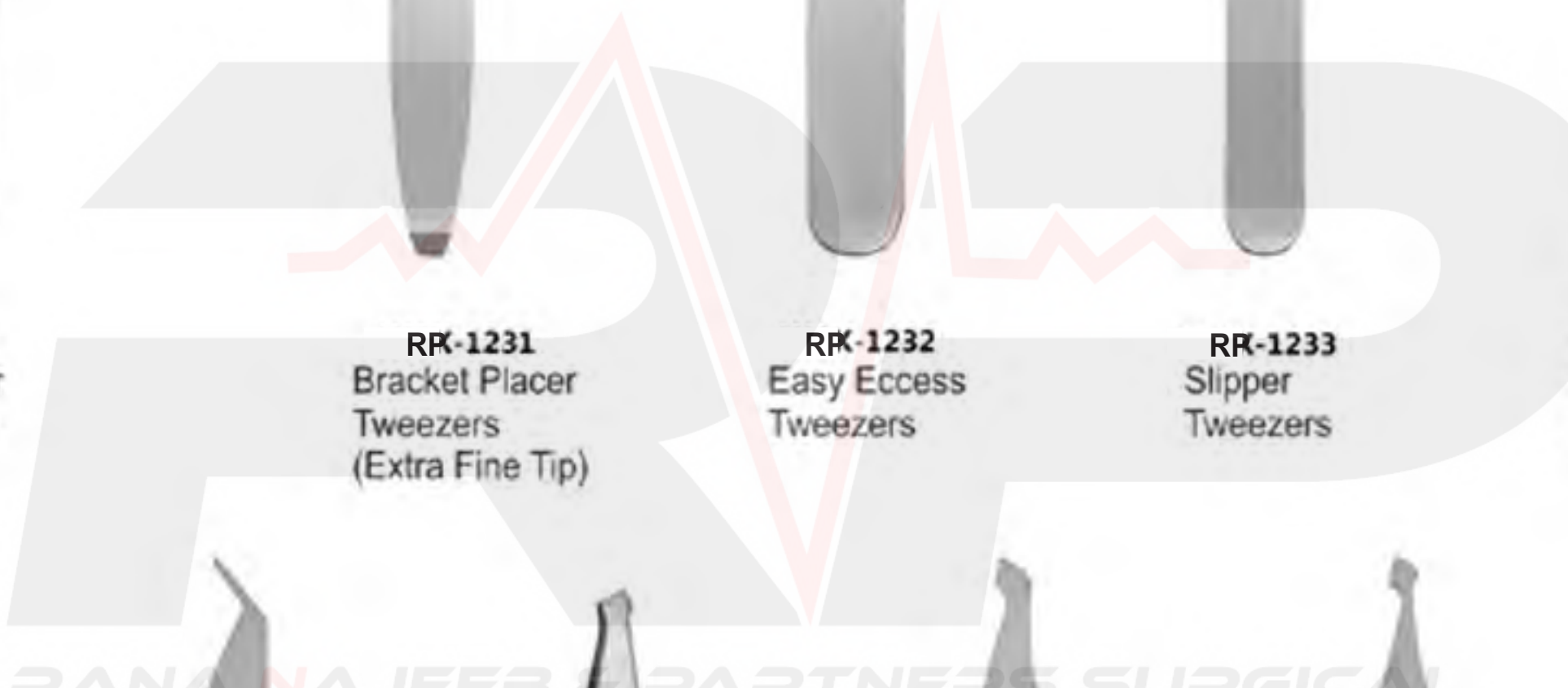

**Caliper / Calipers Rule**



**RP-1241**  
Delux Boley  
Gauge



**RP-1242**  
Boley Gauge



**RP-1243**  
Beerendonk  
130mm  
Mini Gauge



**RP-1244**  
for .018" slot  
Bracket positioning  
Gauges



**RP-1245**  
for .022" slot  
Bracket positioning  
Gauges



**RP-1246**  
OSTEOMETER  
Measuring Forceps For Jaw Ridge Width  
measurement, scale on both sides,  
rustfree, autoclavable



**RP1247**  
Bracket Removing Pliers



**RP1248**  
Bracket Removing Pliers



**RP1249**  
Band removing pliers



**RP1250**  
Band removers curved, Left and Right  
Curved tips provide easy access and grip of band without excess retractor of cheek or lips



**RP1251**  
Left



**RP1252**  
Right  
Pliers for Bands



**RP1253**  
Johnson  
Contouring Pliers



**RP1254**  
Reynolds  
Contouring Pliers



**RP1255**  
For band seating



**RP1256**  
for incisors with convex beaks



**RP1257**  
For bicuspid and molars  
with concave beaks



**RP1258**  
Straight  
Pliers ball hook crimping



**RP1259**  
Angled  
Pliers ball hook crimping



**RP1260**  
Micro distal end cutters T.C  
with safety hold

●	Max. 0.30 mm to 0.50 mm (.012" to .020")
■	Max. 0.46 mm to 0.64 mm (.018" to .025")
⊗	Max. 0.38 mm to 0.53 mm (.0155" to .0215")
⊗	Max. 0.53 mm to 0.64 mm (.021" to .025")



**RP1261**  
Mini distal end cutters T.C  
with safety hold

●	Max. 0.30 mm to 0.50 mm (.012" to .020")
■	Max. 0.46 mm to 0.64 mm (.018" to .025")
⊗	Max. 0.38 mm to 0.53 mm (.0155" to .0215")
⊗	Max. 0.53 mm to 0.64 mm (.021" to .025")



**RP1262**  
Mini with long handles T.C  
distal end cutters with safety hold

●	Max. 0.30 mm to 0.50 mm (.012" to .020")
■	Max. 0.46 mm to 0.64 mm (.018" to .025")
⊗	Max. 0.38 mm to 0.53 mm (.0155" to .0215")
⊗	Max. 0.53 mm to 0.64 mm (.021" to .025")



**RP1263**  
Mini with extra long off-set handles T.C  
distal end cutters with safety hold



●	Max. 0.30 mm to 0.50 mm (.012" to .020")
■	Max. 0.46 mm to 0.64 mm (.018" to .025")
⊗	Max. 0.38 mm to 0.53 mm (.0155" to .0215")
⊗	Max. 0.53 mm to 0.64 mm (.021" to .025")



**RP1264**  
Distal end bending pliers

●	Max. 0.30 mm to 0.50 mm (.012" to .020")
■	Max. 0.56 mm to 0.71 mm (.022" to .028")



**RP1265**  
Weingart mini  
slim design for better accessibility  
in posterior and lingual areas



**RP1266**  
Weingart Narrow  
Narrow long tips for better  
access to hard to reach areas



**RP1267**  
Weingart Utility Pliers  
Standard



**RP1268**

**Weingart Narrow**  
Slim and sleek design with long handles, for better access to posterior area, also suitable for lingual technique



**RP1269**

**Micro Ligature cutters**

0.23 mm to .30 mm (.009" to .012")



**RP1270**

**Mini Ligature cutters**

0.25 mm to .38 mm (.010" to .015")



**RP1271**

**Wire bending and loop forming pliers**  
Angel

0.36 mm to 0.71 mm (.014" to .028")  
Max. 0.56 mm x 0.71 mm (.022" to .028")



**RP1272**

**Wire cutting and loop forming pliers**  
Angel

0.36 mm to 0.50 mm (.014" to .020")  
Max. 0.41 mm x 0.56 mm (.016" to .022")



**RP1273**

**Straight**

**How utility pliers**  
Standard  
4 mm wide tips



0.30 mm to 0.50 mm (.012" to .020")  
Max. 0.56 mm x 0.71 mm (.022" to .028")

**RP1274**

**Angled**



**RP1275**

**Straight**

**How utility pliers**  
Mini  
2.4 mm wide tips



0.30 mm to 0.50 mm (.012" to .020")  
Max. 0.56 mm x 0.71 mm (.022" to .028")

**RP1276**

**Angled**

**Calipers**



**RP1277**  
MEASURING  
GAUGE  
0-10cm



**RP1278**  
CASTROVIEJO CALIPERS  
20mm, 45°  
90mm



**RP1279**  
CASTROVIEJO CALIPERS  
20mm  
90mm



**RP1280**  
CASTROVIEJO CALIPERS  
20mm  
90mm



**RP-1281**  
Bone Thickness  
gauge



**RP-1282**  
Bone Caliper



**RP-1283**  
Weiss Caliper



**RP-1284**  
Caliper



**RP-1285**  
Curved Caliper

RANA NAJEEB & PARTNERS SURGICAL



**RP-1286**

Mini head distal end cutter with safety hold, long handles fitted with un-breakable, corrosion resistant and durable stainless steel tips

- 0.30 mm to 0.50 mm (.012" to .020")
- Max. 0.46 mm x 0.64 mm (.018" x .025")
- ⊗ 0.38 mm to 0.53 mm (.0155" to .0215")
- ⊗ Max. 0.53 mm x 0.64 mm (.021" x .025")



**RP-1287**

Band removing pliers with plastic tip



**RP-1288**

Weingart Utility pliers

- 0.30 mm to 0.50 mm (.012" to .020")
- Max. 0.50 mm x 0.74 mm (.020" to .029")





**RP-1289**

Distal end cutter with safety hold, mini head, long handles. fitted with un-breakable, corrosion resistant and durable stainless steel tips

- 0.30 mm to 0.50 mm (.012" to .020")
- Max. 0.46 mm x 0.64 mm (.018" x .025")
- ⊗ 0.38 mm to 0.53 mm (.0155" to .0215")
- ⊗ Max. 0.53 mm x 0.64 mm (.021" x .025")



**RP-1290**

Flush-cut distal end cutter with safety hold fitted with un-breakable, corrosion resistant and durable stainless steel tips

- 0.30 mm to 0.50 mm (.012" to .020")
- Max. 0.46 mm x 0.64 mm (.018" to .025")



**RP-1291**

Soft wire and ligature cutter, Mini fitted with un-breakable, corrosion resistant and durable stainless steel tips

- ⌋ .25 mm to .38 mm (.010" to .015")



**RP-1292**

Soft wire and ligature cutter, standard fitted with un-breakable, corrosion resistant and durable stainless steel tips

- ⌋ .25 mm to .38 mm (.010" to .015")



**RP-1293**

Soft wire and ligature cutter, 15° angled fitted with un-breakable, corrosion resistant and durable stainless steel tips

- ⌋ .25 mm to .38 mm (.010" to .015")



**RP-1294**

Soft wire and ligature cutter, 45° angled fitted with un-breakable, corrosion resistant and durable stainless steel tips

- ⌋ .25 mm to .38 mm (.010" to .015")



**RP-1295**

Hard wire cutter, straight Fitted with un-breakable, corrosion resistant and durable stainless steel tips

- 0.30 mm to 0.50 mm (.012" to .020")
- Max. 0.56 mm x 0.71 mm (.022" x .028")



**RP-1296**

Hard wire cutter, 15° angled Fitted with un-breakable, corrosion resistant and durable stainless steel tips

- 0.30 mm to 0.50 mm (.012" to .020")
- Max. 0.56 mm x 0.71 mm (.022" x .028")



**RP-1297**

Hard wire cutter, 15° angled Non-autoclavable

- 0.30 mm to 0.50 mm (.012" to .020")
- Max. 0.56 mm x 0.71 mm (.022" x .028")



**RP-1298**  
Band removing pliers



**RP-1299**  
Bracket removing pliers angled



**RP-1300**  
Bracket removing pliers straight



**RP-1301**  
Bracket removing pliers with plastic tip



**RP-1302**  
Adhesive removing pliers



**RP-1303**  
Weingart-mini  
Utility Pliers

● 0.30 mm to 0.50 mm (.012" to .020")  
■ Max 0.56 mm x 0.71 mm (.022" x .028")



**RP-1304**  
Weingart  
Utility Pliers

● 0.30 mm to 0.50 mm (.012" to .020")  
■ Max 0.56 mm x 0.71 mm (.022" x .028")



**RP-1305**  
How Straight  
Utility Pliers

● 0.30 mm to 0.50 mm (.012" to .020")  
■ Max 0.56 mm x 0.71 mm (.022" x .028")

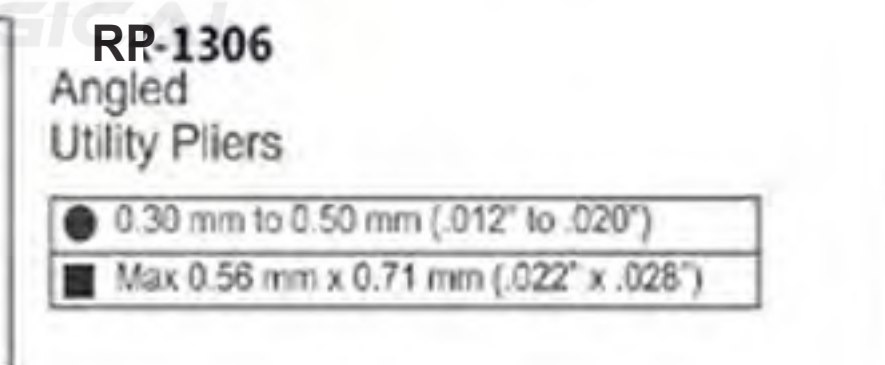

**RP-1306**  
Angled  
Utility Pliers

● 0.30 mm to 0.50 mm (.012" to .020")  
■ Max 0.56 mm x 0.71 mm (.022" x .028")



**RP-1307**  
Wire bending and loop forming pliers  
Angled (Bird beak)

● 0.30 mm to 0.50 mm (.012" to .020")  
■ Max 0.56 mm x 0.71 mm (.022" x .028")

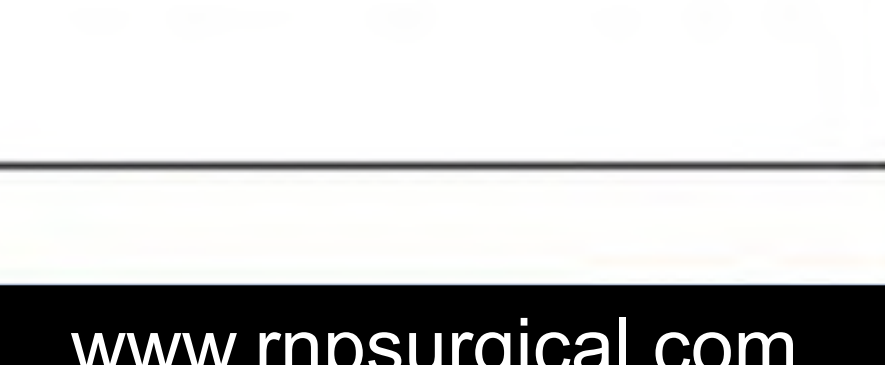

RANA NAJEEB & PARTNERS SURGICAL



**RP-1308**

Light wire bending and loop forming pliers

- 0.30 mm to 0.50 mm (.012" to .020")
- Max 0.41 mm x 0.56 mm (.016" x .022")



**RP-1309**

Light wire bending pliers with cutter fitted with hard metal tips

- 0.30 mm to 0.50 mm (.012" to .020")
- Max 0.46 mm x 0.56 mm (.018" x .022")



**RP-1310**

Light wire bending and loop forming pliers with cutter

- 0.30 mm to 0.50 mm (.012" to .020")
- Max 0.46 mm x 0.56 mm (.018" x .022")



**RP-1311**

Light wire bending and loop forming pliers, grooved tip

- 0.30 mm to 0.50 mm (.012" to .020")
- Max 0.46 mm x 0.56 mm (.018" x .022")



**RP-1312**

Tweed Loop forming pliers with cutter

- 0.30 mm to 0.50 mm (.012" to .020")
- Max. 0.53 mm x 0.64 mm (.021" x .025")



**RP-1313**

Jarabak Light wire bending pliers

- 0.30 mm to 0.50 mm (.012" to .020")
- Max. 0.46 mm x 0.56 mm (.018" x .022")



**RP-1314**

Aderer 3-jaw wire bending pliers

- 0.30 mm to 0.50 mm (.012" to .020")
- Max. 0.56 mm x 0.71 mm (.022" x .028")



**RP-1315**

Ligature forming pliers

- .25 mm to .38 mm (.010" to .015")



**RP-1316**

Hollow-Chop Archwire forming pliers, concave and convex tips

- 0.30 mm to 0.71 mm (.012" to .028")
- Max. 0.56 mm x 0.71 mm (.022" x .028")



**RP1317**

Multi-purpose pliers, bird beak,  
De la rosa and cutter in one

- 0.30 mm to 0.50 mm (.012" to .020")
- Max. 0.46 mm x 0.56 mm (.018" x .022")



**RP1318**

Cinch Back / tie back  
Distal end bending pliers

- 0.30 mm to 0.50 mm (.012" to .020")
- Max. 0.56 mm x 0.71 mm (.022" x .028")



**RP1319**

Hammer head  
Distal end bending pliers

- 0.30 mm to 0.50 mm (.012" to .020")
- Max. 0.56 mm x 0.71 mm (.022" x .028")



**RP1320**

Nance  
Loop forming pliers

- 0.35 mm to 0.71 mm (.014" to .028")
- Max. 0.56 mm x 0.71 mm (.022" x .028")



**RP1321**

Detailing step pliers / Bayonet  
bending pliers - 1mm

- 0.30 mm to 0.50 mm (.012" to .020")
- Max. 0.56 mm x 0.71 mm (.022" x .028")



**RP1322**

Stop pliers V-Bebd - 1mm

- 0.30 mm to 0.50 mm (.012" to .020")
- Max. 0.43 mm x 0.56 mm (.017" x .028")



**RP1323**

Lingual / palatal arch forming plies

- 0.76 mm (.030") / 0.91 mm (.036")



**RP1324**

Torquing pliers set



**RP1325**

Tweed / angel  
Rectangular arch forming and  
torquing pliers

- 0.30 mm to 0.71 mm (.012" to .028")
- Max. 0.56 mm x 0.71 mm (.022" x .028")



**RP1326**

Surgical ball hook crimping pliers,  
angled



**RP1327**

Surgical ball hook crimping  
pliers, straight

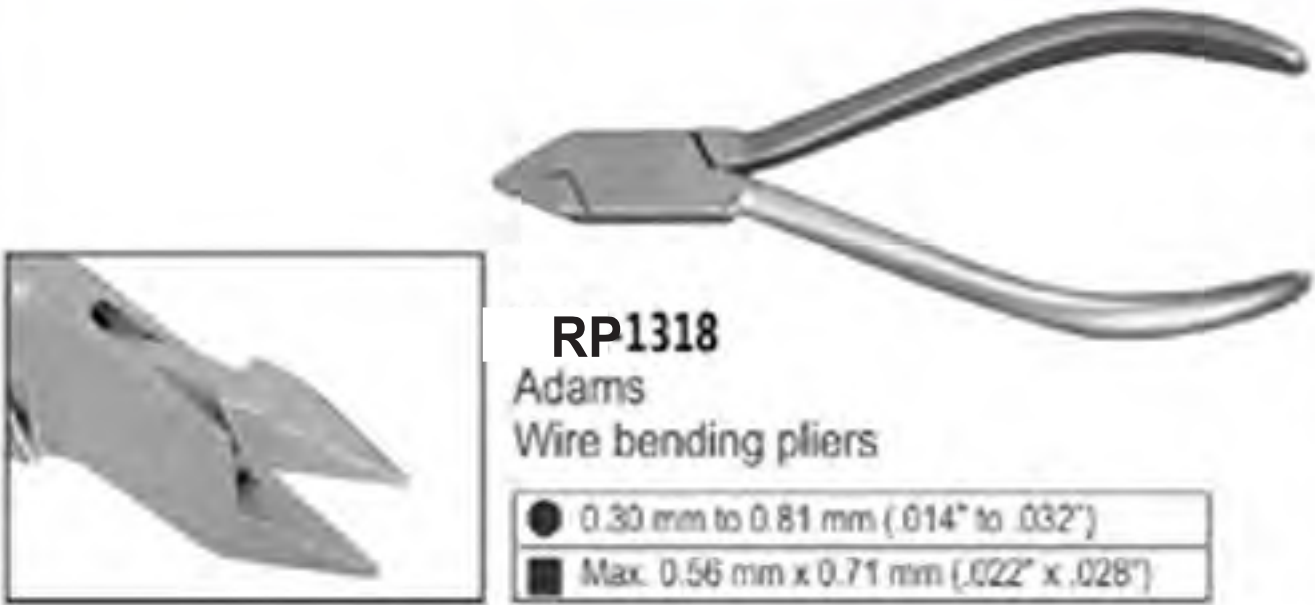

**RP1318**  
Adams  
Wire bending pliers  
● 0.30 mm to 0.81 mm (.014" to .032")  
■ Max. 0.56 mm x 0.71 mm (.022" x .028")



**RP1319**  
Adams  
Wire bending pliers  
● 0.30 mm to 0.81 mm (.014" to .032")  
■ Max. 0.56 mm x 0.71 mm (.022" x .028")



**RP1320**  
Universal small  
Wire bending and cutting pliers  
● Bends: 0.9 mm (.036")  
● Cuts: 0.7 mm (.028")



**RP1321**  
Universal Dolphin style  
Wire bending and cutting pliers  
● Bends: 0.9 mm (.036")  
● Cuts: 0.7 mm (.028")



**RP1322**  
Universal Taper style  
Wire bending and cutting pliers  
● Bends: 0.9 mm (.036")  
● Cuts: 0.7 mm (.028")



**RP1323**  
Waldsachs  
Wire bending and cutting pliers  
● Bends: 0.9 mm (.036")  
● Cuts: 0.7 mm (.028")



**RP-1324**  
Hard wire cutters T.C.  
● 0.70 mm to 1.00 mm (.028" to .040")



**RP-1325**  
Hard wire cutters T.C.  
● 0.70 mm to 1.00 mm (.028" to .040")



**RP-1326**  
Hard wire cutters T.C.  
● 0.60 mm to 0.80 mm (.024" to .032")



**RP-1327**  
Hard wire cutters T.C.  
● 0.60 mm to 0.80 mm (.024" to .032")



**RP-1328**  
Hard wire cutters  
● 0.87 mm to 1.1 mm (.028" to .045")



**RP-1329**  
Hard wire cutters  
● 0.87 mm to 1.1 mm (.028" to .045")



**RP-1330**  
Aderer Clamp three jaw wire bending plier for contouring and bending wire up to .30"/.76mm.



**RP-1335**  
Johnson pliers for crown band contouring



**RP-1331**  
Bird beak plier for bending round, square and rectangle wire up to .30"/.76mm.



**RP-1332**  
Bird beak plier for light wire bending round, square and rectangular up to .016"/0.41mm.

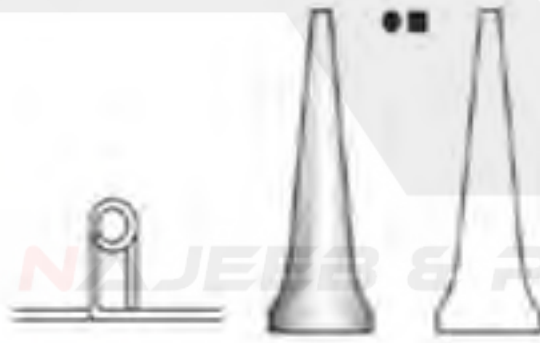

**RP-1333**  
Double Rounded jaw bending pliers, hooks and wire up to .020"/0.51mm.

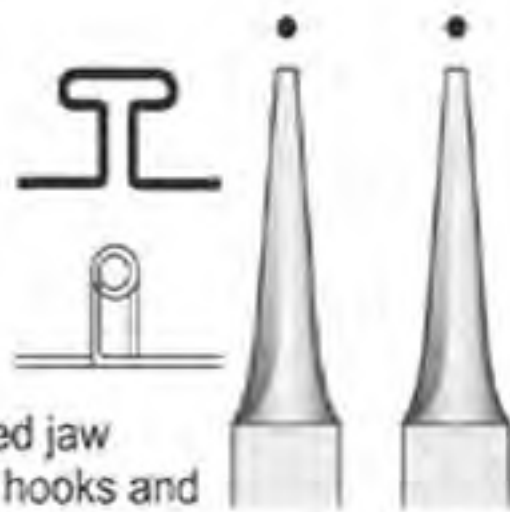

**RP-1334**  
Adams pliers for hooks and bending wire up to .030"/0.76mm.

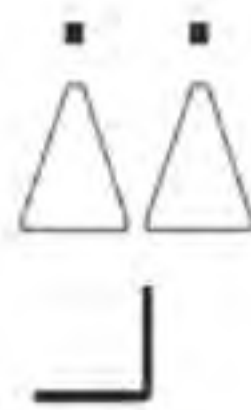

**RP-1336**  
Falcon beak contouring plier.

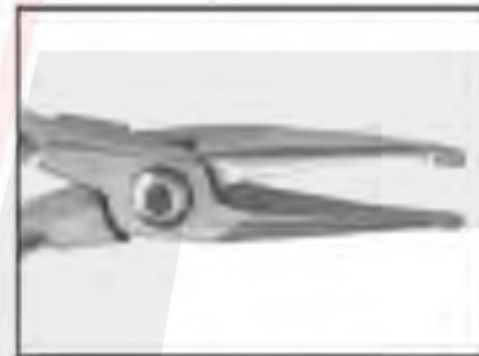

**RP-1337**  
For placement and removal of arch wires, pins and other auxiliaries.



**RP-1338**  
For placement and removal of arch wires, pins and other auxiliaries in angle design



**RP-1339**  
contouring Plier.



**RP-1340**  
Bending plier. In order to skirt molares bands. With grooved. Recommended wire. 016", 018" and 022" 0.41mm, 0.46mm and 0.56mm



**RP-1341**  
Loop forming in four length  
3,4,5 & 6 mm wire capacity  
0.22" / 56mm.

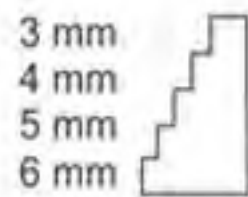

**RP-1342**  
Arch bending plier design for  
convenient handling of square or  
rectangular wire, .020" / 0.51mm.



**RP-1343**  
In order to skirt  
bands and crowns.



**RP-1344**  
Wires up to  
.020" / 0.7mm.

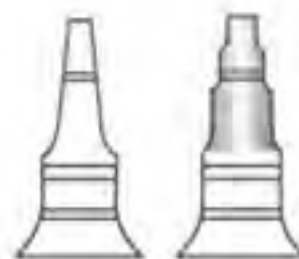

**RP-1345**  
Round and concave plier  
for loop forming and banding  
wire up to .20" / .051mm.



**RP-1346**  
Bending for round square  
or rectangular wire up  
to 0.30"/0.76mm



**RP-1347**  
for double back and triple  
back bands in 0.30" / .76mm  
& 0.36" / .91mm lingual arch wires.



**RP-1348**  
Detailing step plier double-sided  
offset beak permits bayonet bends.  
Creates right hand or left hand  
step-up or stepdown at 1/2, 3/4, or  
1mm increments.



**RP-1349**  
"V" bend stop special design makes  
1mm "v" bends to shorten archwires  
or provide a positive stop. Excellent  
for placing stops in titanium wires.  
For round or rectangular wires up to .025"



**RP-1350**  
Angle how plier efficient utility plier  
with serrated beaks for a firm grip.  
45 angled tips to access hard to  
reach areas.



**RP-1351**  
Weingardt plier serrated tips hold  
wires firmly at a convenient working  
angle. Tapered beaks fit easily  
between brackets and hard to reach  
areas. Our most popular utility plier.

## Papilla Elevators



**RP-1352**  
BUSER  
175 mm



**RP-1353**  
175 mm



**RP-1354**  
PRICHARD 3S  
180 mm



**RP-1355**  
GOLDMANN FOX 14  
175 mm



**RP-1356**  
MOLT 9  
175 mm



**RP-1357**  
PLACEMENT  
INSTRUMENTS  
175 mm





Sinus Lift Instruments:  
Stainless steel, light weight handles Reduce hand and wrist fatigue Variety of elevators and curettes available  
Provides clinicians with the proper instrumentation for lifting the sinus membrane



## Sinus Lift Instruments



**RP-1362**  
Mills-Sinus-1



**RP-1363**  
Mills-Sinus-2



**RP-1364**  
Mills-Sinus-3



**RP-1365**  
Sinus-4



Sinus Lift Instruments



**RP-1366**  
Sinus-1

**RP-1367**  
Sinus-5

**RP-1368**  
Sinus-6

**RP-1369**  
Sinus-Freer

**RP-1370**  
Sinus-Freer-Cu

## Implant & Membrane Surgical Kit

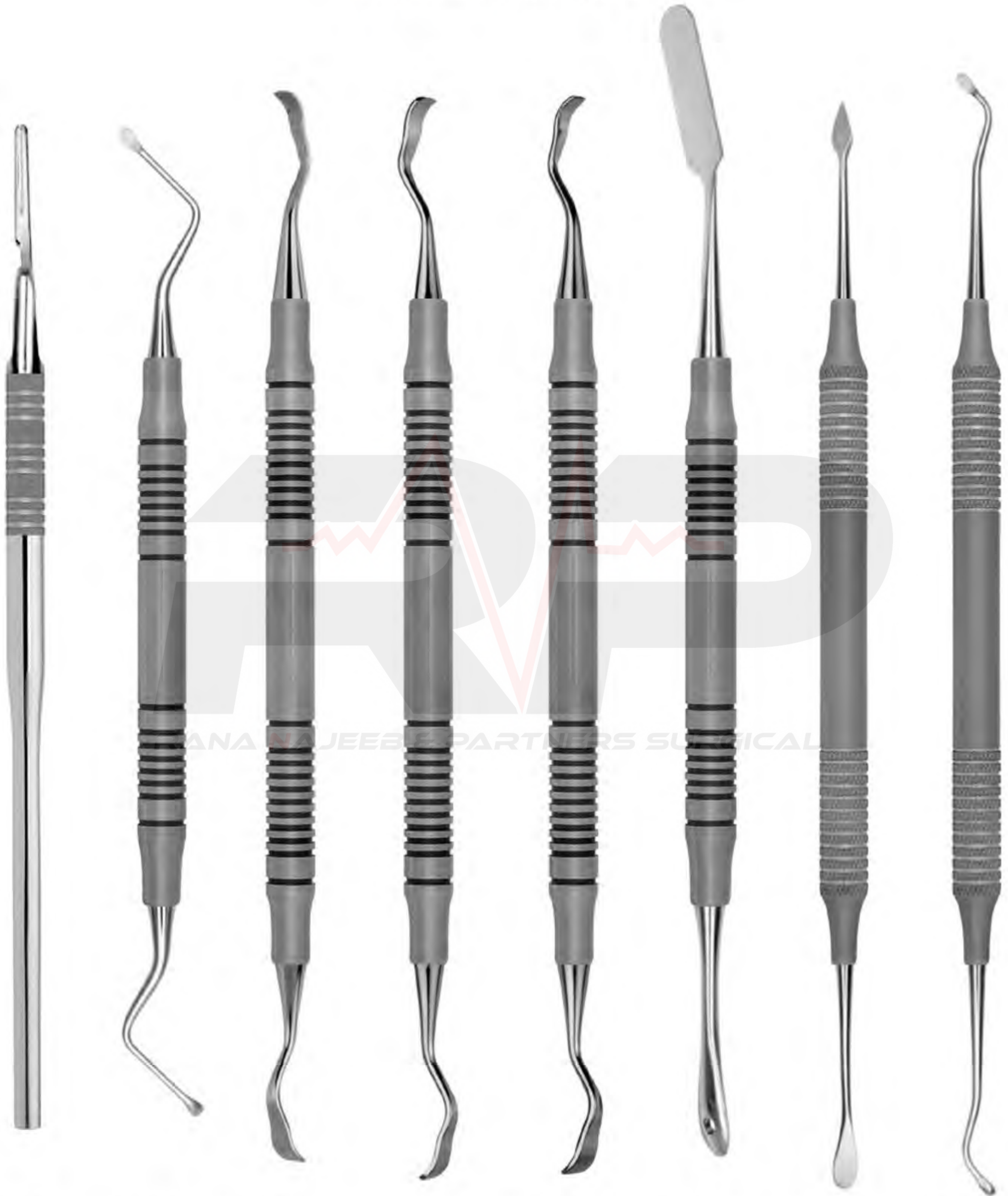

**RP-1371**  
Scalpel  
Handle

**RP-1372**  
Lucas  
Surgical  
Curette

**RP-1373**  
# 1/2  
Buser Modified  
Periodontal

**RP-1374**  
# 2/3  
Buser Modified  
Periodontal

**RP-1375**  
# 1/3  
Buser Modified  
Periodontal

**RP-1376**  
# 9A  
Periosteal

**RP-1377**  
Buser  
Periosteal

**RP-1378**  
# 221  
Darby-Perry  
Excavator

Kramer-nevins Sinus Lift Kit



SL6F  
175mm

**RP1379**

Spare blade, curved 155mm

SL5F  
175mm



**RP-1380**

Bone Scraper, curved of stainless steel 155mm

**RP-1381**

Sinus Lift Instruments Acute

**RP-1382**

Sinus Lift Instruments Obtuse

**RP-1383**

Kramer-Nevins Periosteal

**RP-1384**

Kramer-Nevins Bone Chisel

**RP-1385**

Kramer-Nevins Bone Chisel

**RP-1386**

Edentulous ridge chisel

## Periodontal & Bone Curettes



**RP-1387**  
Prichard ½  
Universal  
Perio Curette

**RP-1388**  
Kramer 1  
Mesial  
Perio Curette

**RP-1389**  
Kramer 2  
Distal  
Perio Curette

**RP-1390**  
Kramer 3  
Universal  
Perio Curette



**RP1391**  
Lucas Bone  
Curettes 75



**RP-1392**  
Lucas Bone  
Curettes 85



**RP1393**  
Lucas Bone  
Curettes 86



**RP-1394**  
Lucas Bone  
Curettes 87



**RP1395**  
Lucas Bone  
Curettes 88

## Micro Surgery & Tunneling Instruments



**RP-1396**  
Tunneling  
Elevator # 1  
17.2 cm

**RP-1397**  
Tunneling  
Elevator # 2  
17.2 cm

**RP-1398**  
Orban 1/2  
Short  
17.2 cm

**RP-1399**  
Orban 1/2  
Long  
17.2 cm

**RP-1400**  
Younger Good 7/8  
9.5 mm Wide Tip



Micro Surgery & Tunneling Instruments  
Perio Micro Surgery Instruments

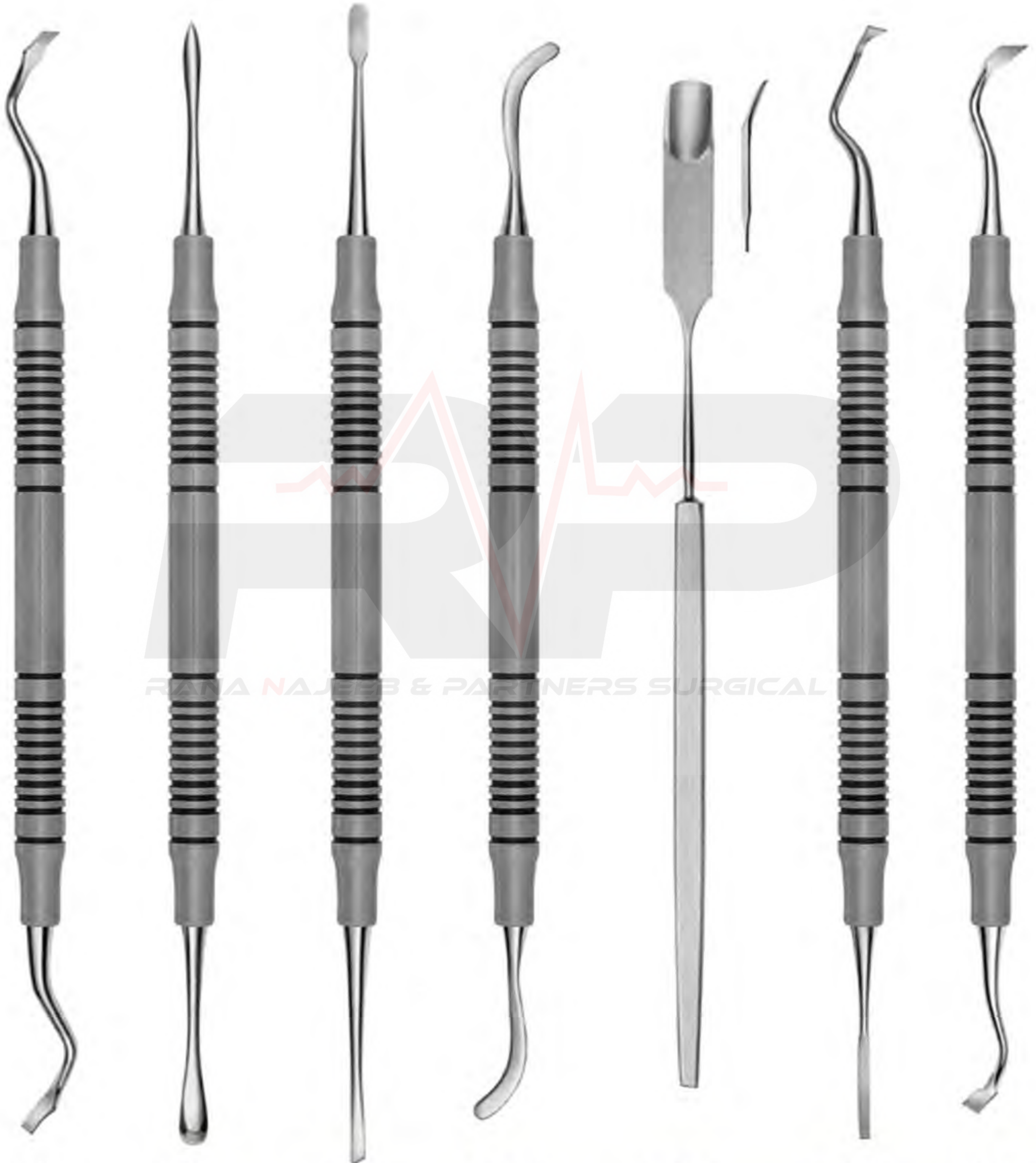

**RP-1401**  
Rhodes Chisel  
17.2 cm

**RR-1402**  
Micro Elevator 1  
17.2 cm

**RP-1403**  
Micro Elevator 2  
17.2 cm

**RR-1404**  
Micro Elevator 3  
17.2 cm

**RR-1405**  
Micro Retractor  
9.5 mm Wide Tip

**RR-1406**  
Micro Chisel 1  
17.2 cm

**RR-1407**  
Micro Chisel 2  
17.2 cm

## Periosteal Elevators



**RP-1408**  
Freer



**RP-1409**  
Buser



**RP-1410**  
Quinn



**RP-1411**  
Hirschfeld 20



RANA NAJEEB & PARTNERS SURGICAL

Periosteal Elevators



**RP-1412**  
24G Elevator



**RP-1413**  
Henahan Retractor  
Large



**RP-1414**  
West



**RP-1415**  
Woodson



## Periosteal Elevators



**RP1416**  
Goldman-Fox Elevator  
17cm



**RP1417**  
Molt 2/4



**RP1418**  
Molt 2 Angled  
Double-Ended



**RP1419**  
Molt 4 Angled  
Double-Ended



**RP-1420**  
Molt 4 With  
Suture Hole



**RP-1421**  
Molt 9



**RP-1422**  
Molt 2



**RP-1423**  
Molt 4

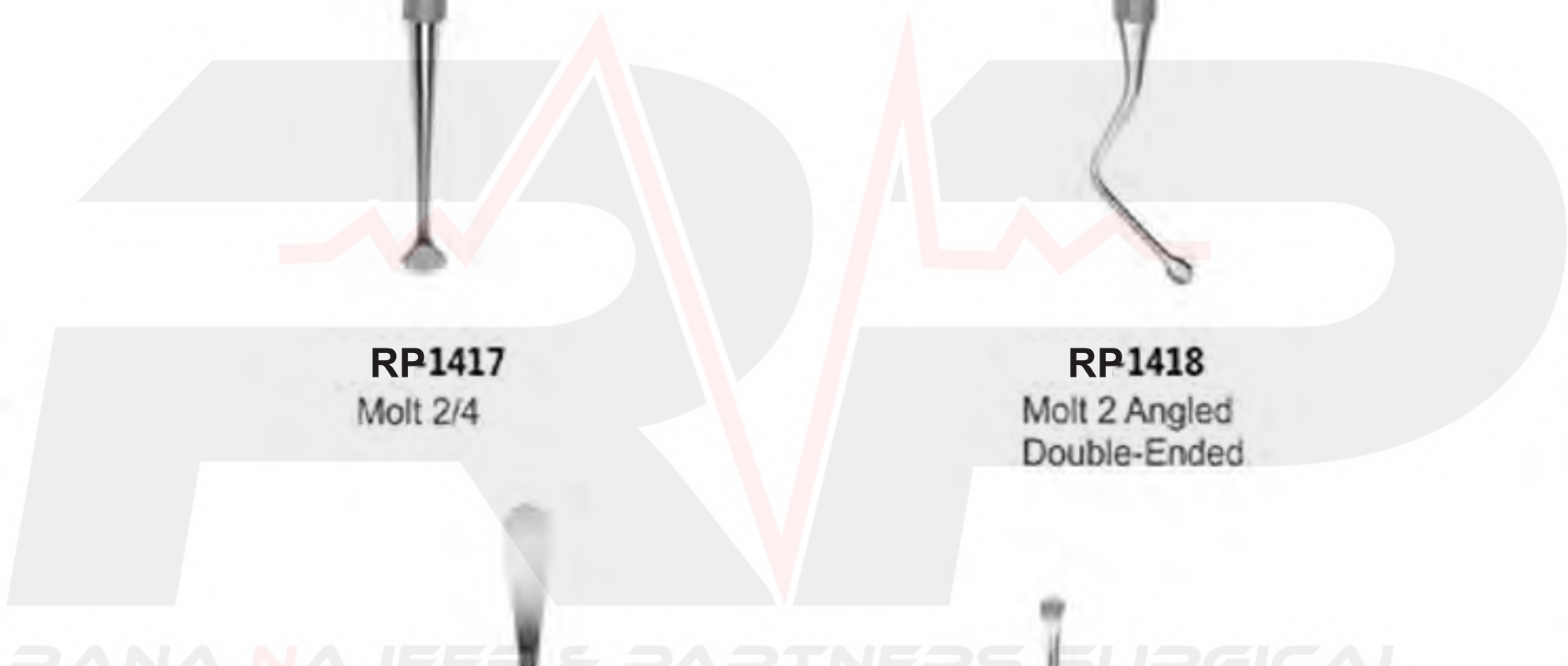

RANA NAJEEB & PARTNERS SURGICAL

## Atraumatic Extraction Bayonet Root Elevators



**RP-1424**  
Bayonet Elevator  
Straight



**RP-1425**  
Bayonet Elevator  
Offset "In" Small



**RP-1426**  
Bayonet Elevator  
Offset "Out" Small



**RP-1427**  
Bernard Bayonet Elevator  
Offset Left



**RP-1428**  
Bernard Bayonet Elevator  
Offset Right

## Implant Periosteals



**RP-1429**  
LaBanca



**RP-1430**  
LaBanca  
Modified



**RP-1431**  
Buser



**RP-1432**  
# PA



**RP-1433**



**RP-1434**  
Sicilia



**RP-1435**  
Sicilia



## Implant Periosteals



**RP-1436**  
Sinus Lift  
Instrument



**RP-1437**  
Sinus Lift  
Instrument  
3mm



**RP-1438**  
Sinus Lift  
Instrument  
3.5mm



**RP-1439**  
Zingheim  
Knife



**RP-1440**  
Zingheim  
Periosteal



**RP-1441**  
Zingheim  
Periosteal

Implant Chisels



**RP-1442**  
Buser Modified  
Periodontal  
Chisel  
3mm/4mm



**RP-1443**  
# 2/3  
Buser Modified  
Periodontal Chisel  
4mm/5mm



**RP-1444**  
# 1/3  
Buser Modified  
Periodontal Chisel  
3mm/5mm



**RP-1445**  
# TG  
Jovanovic  
4mm



**RP-1446**  
# TG  
Jovanovic  
5mm



**RP-1447**  
# TG  
Jovanovic  
6mm





## Bone Scoops



**RP1448**  
# 13KL  
Palacci  
Modified



**RP1449**  
# 20mm  
Probe



**RP1450**  
Jovanovic  
Bone Scoop



**RP1451**  
Bone Graft  
Scoop



**RP1452**  
LaBanca  
Bone Curette



**RP1453**  
# 3x1.5mm  
LaBanca



**RP1454**  
Jovanovic

## Sinus Lift Instruments



786-1510  
Kramer-Nevins  
Acute

786-1511  
Kramer-Nevins  
Obtuse

786-1512  
Sinus Lift  
Instruments

786-1513  
Single-End Sinus Lift  
Instruments 3mm

786-1514  
Sinus Lift  
Instrument

Bone Files

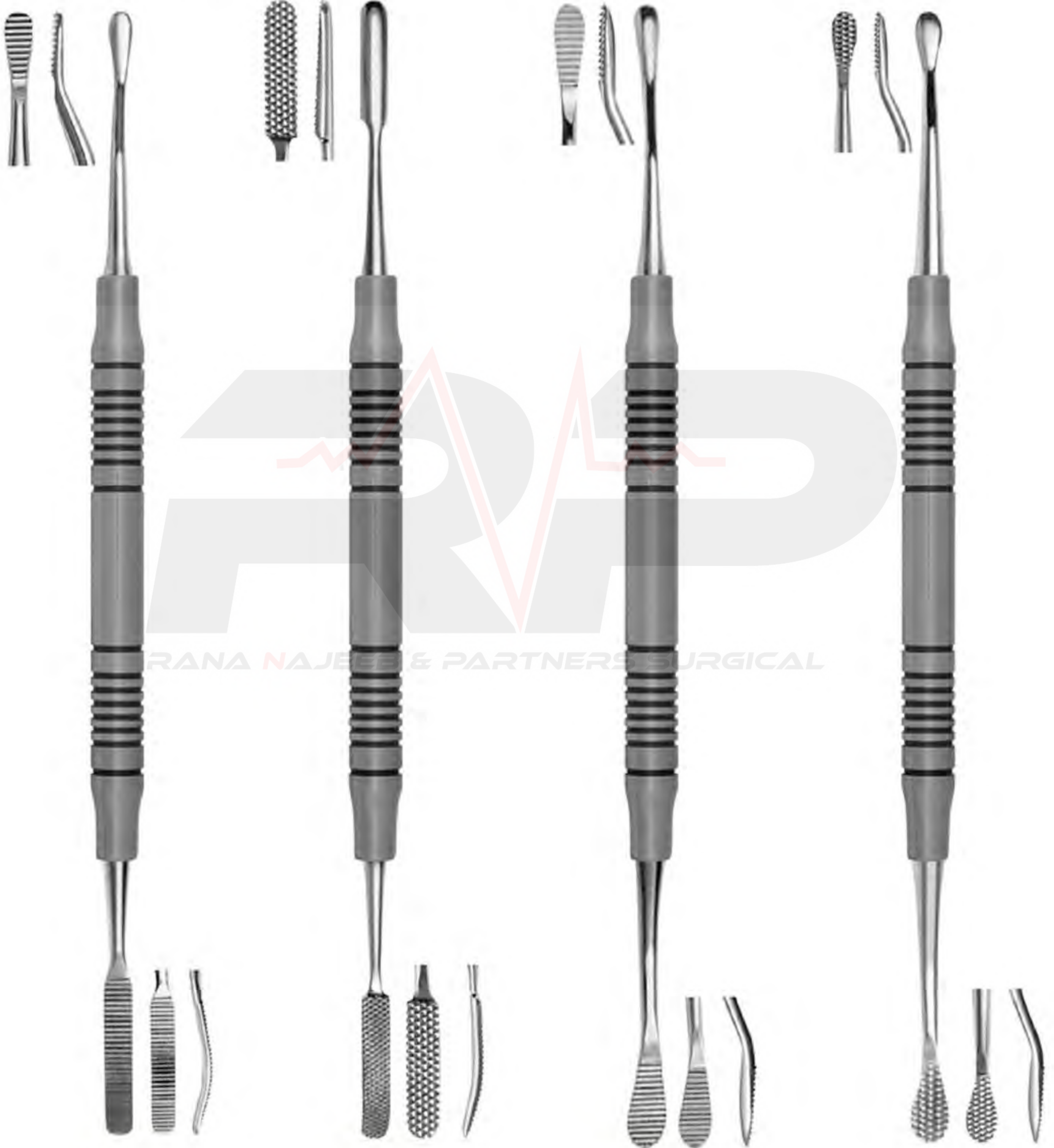

**RP-1460**  
Bone File 10

**RP-1461**  
Bone File 10CA

**RP-1462**  
Bone File 12

**RP-1463**  
Bone File 12CA

## Manual Bone Mill, Holding & Drilling Forceps

Ideal for Chairside Preparation of  
Autogenous Bone Grafts  
Bone Morselizer Bone Morselizer  
Bone morselizer



**RP1464**

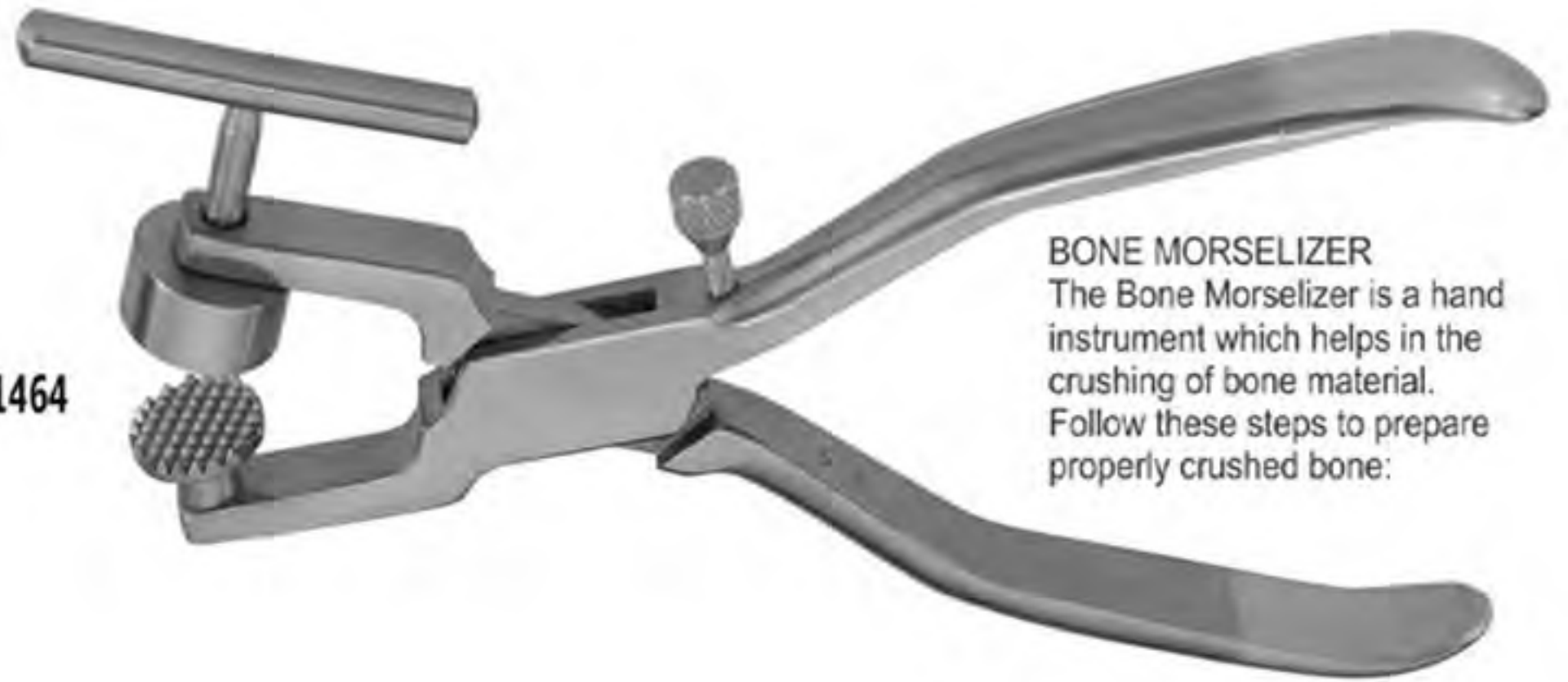

**BONE MORSELER**  
The Bone Morselizer is a hand instrument which helps in the crushing of bone material. Follow these steps to prepare properly crushed bone:

1. Adjust the spacing screw (located at the hinge of the handles) to the desired spacing requirements between knurled surfaces.



2. Place the bone material into the bone well.



3. Compress handles together in order to create pressure on the bone material.



4. Turn the bone morselizer clockwise as the handles are squeezed. Always maintain a slight space between the two knurled surfaces, by using the spacing screw.



5. To remove bone, press the T-handle and bone will express from the bone well.

RANA NAJEEB & PARTNERS SURGICAL



**RP-1465**

EASY Bone Manual  
Bone Mill to chop Bone  
Fragments



**RP-1466**  
Bone Mill



**RP-1467**  
Basins For Bone

## Bone Grafting Instruments Compactor /tampers

Product offering includes instruments for harvesting, mixing and compacting bone Provides clinicians with the proper instrumentation for bone grafting procedures Weighted bone basin Prevents tipping and spilling of bone and other materials during mixing



**RP1468**  
GRAFT PACKER, CONCAVE  
TIPS DE 4/6mm



**RP1469**  
BONE SPOON/ PACKER DE 3mm



**RP1470**  
GRAFT PACKER, SERRATED TIPS  
DE 6/8mm



**RP1471**  
GRAFT PACKER, SERRATED  
TIPS DE 3/4mm

## Bone Grafting Instruments Compactor / tampers



**RP-1472**  
GRAFT PACKER, SMOOTH  
TIPS DE 5/8mm



**RP-1473**  
Titanium graft packer / placement  
site depth gauge 3.3mm & 4.0mm Diameter  
tips Marked at 8, 11, 13, 15 & 18mm



**RP-1474**  
Graft Material Spoon With  
3mm Serrated Graft Packer  
Concave Spoon Tip For  
Larger Grafts



**RP-1475**  
Graft Material Spoon  
Concave Tip For  
Larger Grafts



TISSUE PUNCH

4.0mm ●



5.0mm ●



6.0mm ●



Stainless Steel Tissue  
Punches - Straight  
**RP1476** 4.0mm Straight Punch  
**RP1477** 5.0mm Straight Punch  
**RP1478** 6.0mm Straight Punch

2.0mm ●



**RP1479**

4.0mm ●



**RP1480**

5.0mm ●



**RP1481**

6.0mm ●



**RP1482**

7.0mm ●



**RP1483**

8.0mm ●



**RP1484**

Stainless Steel Tissue Punches - Offset

Extracting Forcesps



RP-1484



RP-1485



RP-1486



RP-1487



RP-1488



RP-1489



## Extracting Forcesps



RP1490



RP1491



RP1492



RP1493



RP1494



RP1495



RP1496

## Extracting Forcesps



**RP-1497**  
Fig. 34



**RP-1498**  
Fig. 34A



**RP-1499**  
Fig. 35



**RP-1500**  
Fig. 35A



**RP-1501**  
Fig. 36



**RP-1502**  
Fig. 36A



**RP-1503**



**RP-1504**  
Fig. 67



**RP-1505**  
Fig. 79

## Extracting Forcesps



**RP-1506**  
Fig. 67A



**RP-1507**  
Fig. 79A



**RP-1508**  
Fig. 45Z



**RP-1509**  
Fig. 51Z

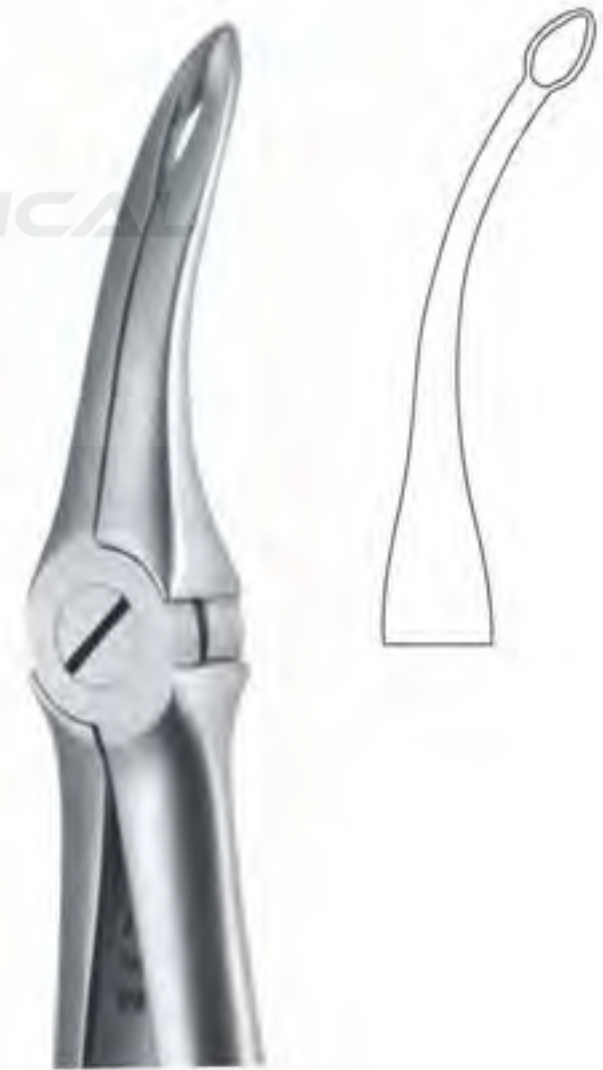



**RP-1510**  
Fig. 44Z

Chisels / Osteotomes



  
**RP1511** Ø 2.0mm  
**RP1512** Ø 2.7mm  
**RP1513** Ø 3.2mm  
**RP1514** Ø 4.2mm  
**RP1515** Ø 5.0mm  
 160mm

  
**RP1516** Ø 2.0mm  
**RP1517** Ø 2.7mm  
**RP1518** Ø 3.2mm  
**RP1519** Ø 4.2mm  
**RP1520** Ø 5.0mm  
 160mm

  
**RP-1521** Ø 2.0mm  
**RP-1522** Ø 2.7mm  
**RP-1523** Ø 3.2mm  
**RP-1524** Ø 4.2mm  
**RP-1525** Ø 5.0mm  
 175mm

  
**RP-1526** Ø 2.0mm  
**RP-1527** Ø 2.7mm  
**RP-1528** Ø 3.2mm  
**RP-1529** Ø 4.2mm  
**RP-1530** Ø 5.0mm  
 175mm

## Steri Wash Tray System



**RP-1531**

Oral Surgery Kit (C)  
Exterior Dimensions 14.5" x 8" x 1.25"  
(368mm x 203mm x 32mm)



**RP-1532**  
Mini Cassette  
For 5 Instruments  
180 x 70 x 25 mm

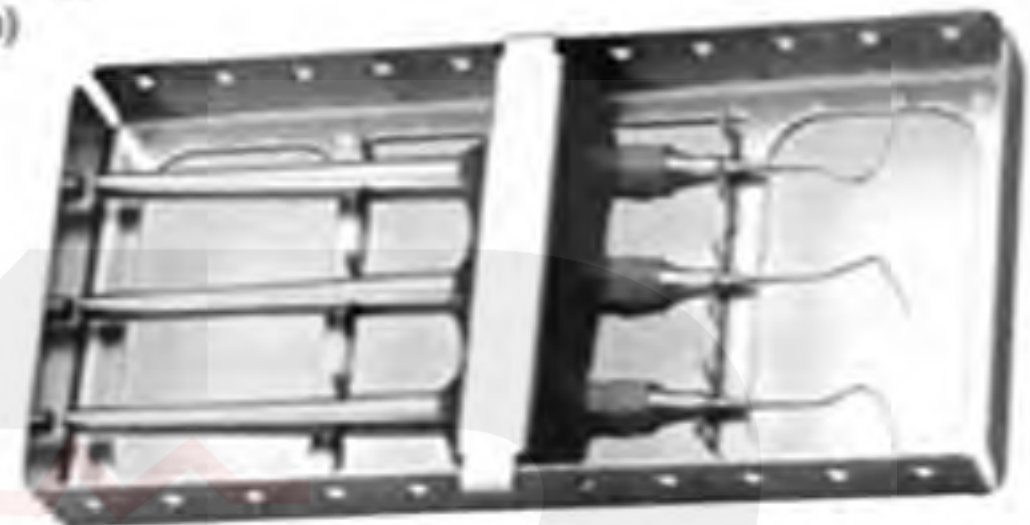

**RP-1533**  
Economy Cassette  
For 5 Instruments  
180 x 85 x 19 mm



**RP-1534**  
Small Cassette  
For 10 Instruments  
140 x 203 x 32 mm



**RP-1535**  
Maxi Cassette  
For 16 Instruments  
280 x 180 x 30 mm



**RP-1536**  
Large Cassette  
For 16 Instruments  
230 x 280 x 32 mm  
with an  
Accessory Area



**RP-1537**  
Large Cassette  
For 20 Instruments  
230 x 280 x 32 mm

# STERILE WASH TRAY SYSTEM

## Steri Wash Tray System

Easy To use  
Fully Hygienic  
Time Saving  
Longer Instrument Lift  
Modern & Practical Design



**RP1538**  
Instruments Tray  
Dimensions  
182 x 72 x 34 mm



**RP1539**  
Instruments Tray  
Dimensions  
182 x 144 x 34 mm



**RP1540**  
Instruments Tray  
Dimensions  
288 x 182 x 34 mm  
Locking System

**ECONOMY STERI WASH TRAY SYSTEM**  
Instrument Tray Complete with  
Base, Lid, Silicon Insert Frame & Holder  
Locking System



**RP1541**  
Instruments Tray  
Dimensions  
182 x 144 x 34 mm

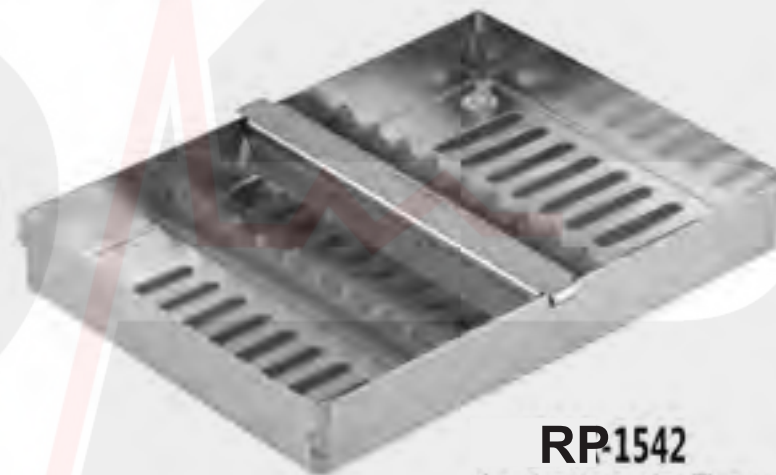

**RP1542**  
Instruments Tray  
Dimensions  
182 x 144 x 34 mm



RANA NAJEEB & PARTNERS SURGICAL



**RP1543**  
Instruments Tray  
Dimensions  
185 x 65 x 22 mm



**RP1544**  
Instruments Tray  
Dimensions  
185 x 130 x 22 mm



**RP1545**  
Instruments Tray  
Dimensions  
280 x 180 x 25 mm

## Steri Wash Tray System



- Sizes:
- RP-1546 240x130x50mm
  - RP-1547 240x130x60mm
  - RP-1548 240x250x50mm
  - RP-1549 240x250x60mm
  - RP-1550 480x250x50mm
  - RP-1551 480x250x60mm
  - RP-1552 480x250x70mm



**MESH TRAYS**  
Different sizes & dimensions are available at buyer's demand

- SIZES:
- RP-1553 240x250x50mm
  - RP-1554 240x250x60mm
  - RP-1555 240x250x70mm
  - RP-1556 480x250x50mm
  - RP-1557 480x250x60mm
  - RP-1558 480x250x70mm
  - RP-1559 480x250x100mm



- Sizes:
- RP-1560 240x250x50mm
  - RP-1561 240x250x60mm
  - RP-1562 240x250x70mm
  - RP-1563 280x250x50mm
  - RP-1564 280x250x60mm



- Sizes:
- RP-1565 280x250x70mm
  - RP-1566 280x250x100mm
  - RP-1567 280x250x50mm
  - RP-1568 280x280x60mm
  - RP-1569 280x280x70mm
  - RP-1570 300x280x60mm

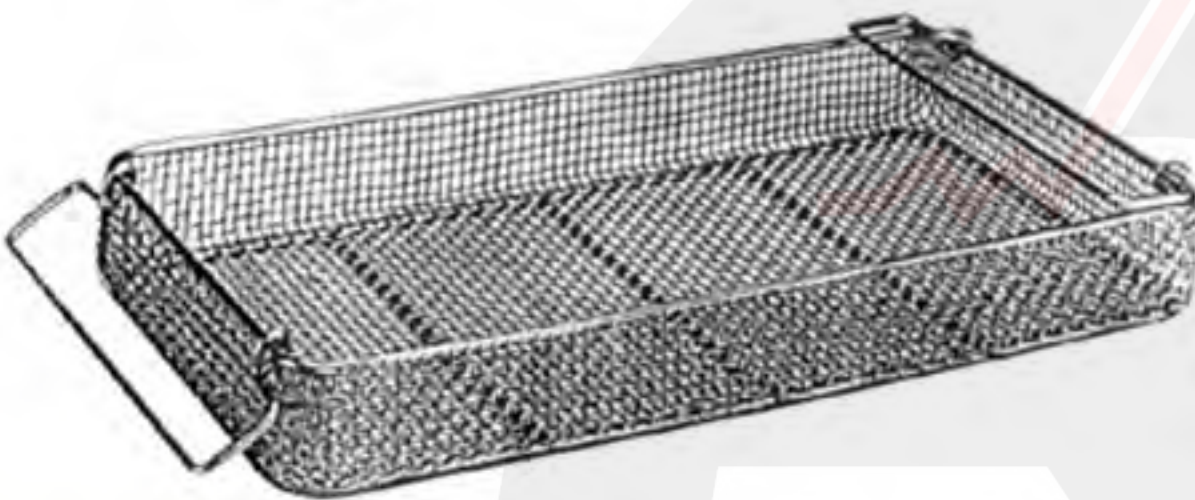

### MESH BASKET

- RP-1571 480 x 258 x 50 mm
- RP-1572 480 x 258 x 100 mm
- RP-1573 520 x 258 x 60mm
- RP-1574 520 x 258 x 70mm
- RP-1575 450 x 340 x 70mm
- RP-1576 320 x 230 x 70mm

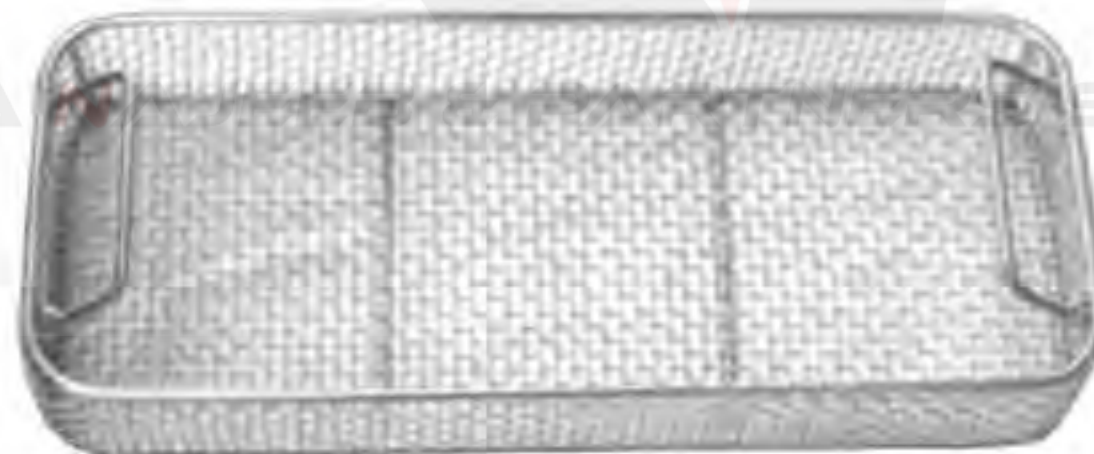

**ARTHROSCOPE BASKET**  
RP-1599 290 x 80 x 52 mm

### MESH BASKET

With Perforated Sheet Side

- RP-1580 230 x 130 x 50 mm
- RP-1581 230 x 130 x 60 mm
- RP-1582 240 x 130 x 50 mm
- RP-1583 240 x 130 x 60 mm
- RP-1584 240 x 250 x 50 mm
- RP-1585 240 x 250 x 60 mm
- RP-1586 480 x 250 x 50 mm
- RP-1587 480 x 250 x 60 mm
- RP-1588 480 x 250 x 70 mm
- RP-1589 300 x 300 x 50 mm
- RP-1590 350 x 350 x 60 mm
- RP-1591 470 x 400 x 60 mm
- RP-1592 480 x 480 x 50 mm
- RP-1593 480 x 480 x 60 mm
- RP-1594 500 x 300 x 50 mm
- RP-1595 520 x 300 x 50 mm
- RP-1596 520 x 300 x 60 mm
- RP-1597 550 x 430 x 50 mm
- RP-1598 600 x 300 x 60 mm

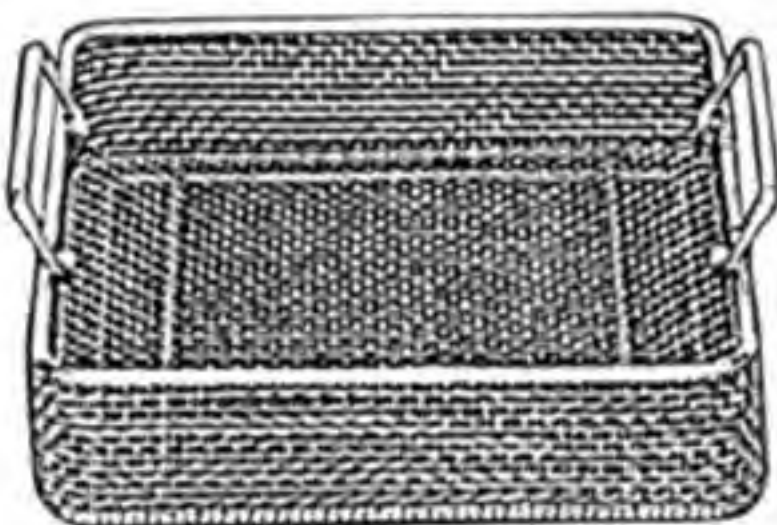

### MESH BASKET

- RP-1577 240 x 258 x 50 mm
- RP-1578 250 x 240 x 100 mm
- RP-1579 240 x 250 x 60mm



**ENDOSCOPE BASKET**  
RP-1600 460 x 80 x 52 mm  
RP-1601 660 x 80 x 52 mm  
RP-1602 670 x 80 x 52 mm



786-1659  
Extracting Forceps, American Pattern. F/X



786-1664  
Le Cron Carver.



786-1660  
Extracting Forceps, American Pattern.



786-1665  
Tweezers (Beauty)



786-1661  
Extracting Forceps, English Pattern.



786-1666  
Retractor.



786-1662  
Root Elevator.



786-1667  
Mirror Handle with Mirror.



786-1663  
Nipper





786-1668  
 Pliers. Young.



786-1673  
 Scissor



786-1669  
 Syringe Folding.



786-1674  
 Needle Holder



786-1670  
 Iwason Caliper.



786-1675  
 Impression Tray Perforated



786-16741  
 Nasal Specula



786-1676  
 Impression Trays, Solid.



786-1672  
 Dressing Tweezers.



✉ info@rnpsurgical.com

☎ +92-332-8745 590

🌐 www.rnpsurgical.com

📍 Shadiwal Gondal Road Sialkot, Pakistan.

### **Oman Address**

C.R. No: 1467215, P.O.Box : 1309, P.C : 121, Muscat, Sultanate of Oman

GSM : +968 9636123

+968-99252583

✉ rananajeebnptrd@gmail.com